

CHECKLINE®
MADE TO MEASURE

OWNER'S MANUAL

Digital Adjustable Spanner
DWA Series



Dear Users

Thank you for using digital adjustable spanner. This manual will help you to use the many features of your new digital adjustable spanner. **Before operating the adjustable spanner, please read this manual completely**, and keep it nearby for future reference.

MAIN FEATURES

- Digital torque value readout
- +/- 3% accuracy (20%~100% of F.S.)
- CW operation
- Peak Hold and Track Mode Selectable
- Buzzer and LED indicator for the 9 pre-settable target torques
- Four Units Selectable(N-m, ft-lb, in-lb, kg-cm)
- 50 or 250 data memory for recall and joint torque auditing
- Communication functions
- Auto Sleep after about 5 minutes idle
- Both AA and rechargeable batteries are compatible
- The “Moving Jaw” has a special design with the positioning portion for keeping the same constant distance with different size of bolts.(This patent has been approved by several countries)

NAMES AND FUNCTIONS OF PARTS

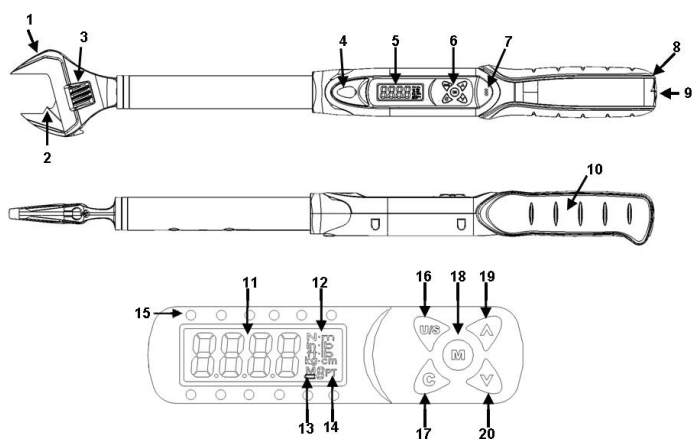

- | | |
|------------------------|--------------------------------------|
| 1. Jaw | 12. Units Selection |
| 2. Positioning Portion | 13. Pre-setting No. |
| 3. Knurl | 14. P(Peak Hold)/T(Track) Mode |
| 4. Communication Port | 15. LED Indicator |
| 5. LCD Display | 16. Unit Selection/Setting Button |
| 6. Buttons | 17. Power On/Clear Button |
| 7. Buzzer | 18. Pre-setting No. Selection Button |
| 8. Battery Compartment | 19. Up Button |
| 9. Battery Cap | 20. Down Button |
| 10. Anti-slip Handle | |
| 11. Torque Value | |

SELECTION GUIDE

MODEL NO:	①	②	③
	DAW-060N	C	N
	DAW-135N		
DAW-340N			

① :

Model	Open Size (mm)	Max. Torque
DAW-060N	5~26	60 N-m / 44.24 ft-lb / 530.9in-lb / 612.2 kg-cm
DAW-085N	5~26	85N-m / 62.7 ft-lb / 752in-lb / 867 kg-cm
DAW-135N	5~26	135N-m / 99.5 ft-lb / 1195in-lb / 1378 kg-cm
DAW-135N	5~30	135N-m / 99.5 ft-lb / 1195in-lb / 1378 kg-cm
DAW-200N	5~30	200N-m / 147.5ft-lb / 1770in-lb / 2041 kg-cm
DAW-200N	10~41	200N-m / 147.5ft-lb / 1770in-lb / 2041 kg-cm
DAW-340N	10~41	340N-m / 250.7ft-lb / 3009in-lb / 3469 kg-cm

② :

Accuracy	
C	+/- 3%-CW

③ :

Communication	
N	No
R	Yes

SPECIFICATIONS

Model No.	Max. Torque (N-m)	Torque Measuring Range (N-m)	Length (mm)
DAW-060N	60	3~60	428
DAW-085N	85	4.2~85	428
DAW-135N	135	6.8~135	428
All Models			
Accuracy *1	CN	CR	
	± 3%		
Data memory size	50	250	
Communication *2	No	Yes	
Bright LED	12 LEDs (2 Red+10 Green)		
Pre-setting No.	9 sets		
Operation Mode	Peak hold/Track		
Unit Selection	N-m, in-lb, ft-lb, kg-cm		
Head Type	Spanner		
Open End Size(mm)*3	5~27		
Button	5		
Battery *4	AA X 2		
Operating Temperature	-10°C ~60°C		
Storage Temperature	-20°C ~70°C		
Humidity	Up to 90% non-condensing		
Drop Test	1 m		
Vibration Test *5	10G		
Environmental test *6	Pass		
Electromagnetic compatibility test *7	Pass		

NOTE: Accuracy is guaranteed from 20% to 100% full scale.

* : See note on page 6

Model No.	Max. Torque (N-m)	Torque Measuring Range (N-m)	Length (mm)
DAW-135N	135	6.8~135	525
DAW-200N	200	10~200	525
All Models			
Accuracy *1	CN	CR	
	± 3%		
Data memory size	50	250	
Communication *2	No	Yes	
Bright LED	12 LED (2 Red+10 Green)		
Pre-setting No.	9 sets		
Operation Mode	Peak hold/Track		
Unit Selection	N-m, in-lb, ft-lb, kg-cm		
Head Type	Spanner		
Open End Size(mm)*3	5~30		
Button	5		
Battery *4	AA X 2		
Operating Temperature	-10°C ~60°C		
Storage Temperature	-20°C ~70°C		
Humidity	Up to 90% non-condensing		
Drop Test	1 m		
Vibration Test *5	10G		
Environmental test *6	Pass		
Electromagnetic compatibility test *7	Pass		

NOTE: Accuracy is guaranteed from 20% to 100% full scale.

* : See note on page 6

Model No.	Max. Torque (N-m)	Torque Measuring Range (N-m)	Length (mm)
DAW-200N	200	10~200	650
DAW-340N	340	17~340	650
All Models			
Accuracy *1	CN	CR	
	± 3%		
Data memory size	50	250	
Communication *2	No	Yes	
Bright LED	12 LED (2 Red+10 Green)		
Pre-setting No.	9 sets		
Operation Mode	Peak hold/Track		
Unit Selection	N-m, in-lb, ft-lb, kg-cm		
Head Type	Spanner		
Open End Size(mm)*3	10~41		
Button	5		
Battery *4	AA X 2		
Operating Temperature	-10°C ~60°C		
Storage Temperature	-20°C ~70°C		
Humidity	Up to 90% non-condensing		
Drop Test	1 m		
Vibration Test *5	10G		
Environmental test *6	Pass		
Electromagnetic compatibility test *7	Pass		

NOTE: Accuracy is guaranteed from 20% to 100% full scale.

* : See note on page 6

Note:

- *1: The accuracy of the readout is guaranteed from 20% to 100% of maximum range +/- 1 increment. The torque accuracy is a typical value. Calibration point is at the middle line of the five anti-slip lines on the rubber grip. For keeping the accuracy, calibrate the spanner for a constant period time (1 year).
- *2: Use a special designed RS232 cable (accessory) to upload record data to PC.
- *3: The “Moving Jaw” has a special design concept with “Positioning Portion” which keeps constance distance from the center of the bolts to the center of the handle when the bolt head is fixed to “Positioning Portion”. And this will keep the same accuracy with different sizes and spec of bolts.

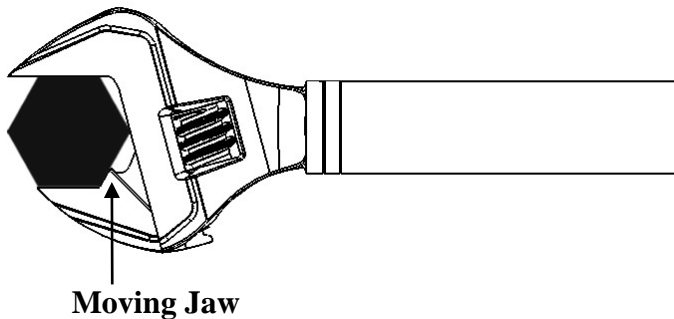

- *4: Two AA batteries (Toshiba carbon-zinc battery)
- *5: Horizontal and vertical test.
- *6: Environmental test:
 - a. Dry heat
 - b. Cold
 - c. Damp heat
 - d. Change of temperature
 - e. Impact (shock)
 - f. Vibration
 - g. Drop
- *7: Electromagnetic compatibility test:
 - a. Electrostatic discharge immunity (ESD)
 - b. Radiated susceptibility
 - c. Radiated emission

BEFORE USING THE SPANNER

BATTERY INSTALLATION

- Remove the battery cap.
- Insert two R6/AA batteries matching the -/+ polarities of the battery to the battery compartment.
- Put on the battery cap and rotate it tightly according to the following figures.

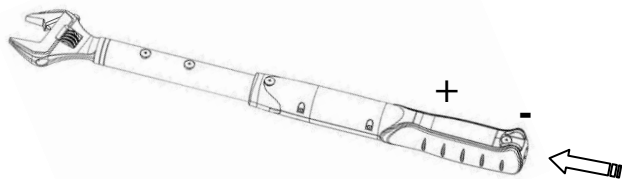

Direction of Battery and Cap Installation

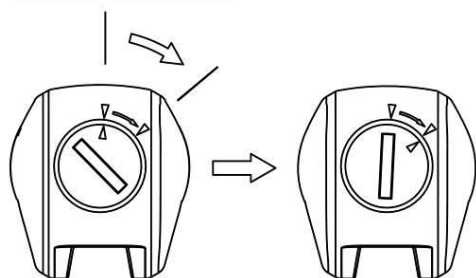

POWER ON AND RESETTING THE SPANNER

- Press **C** to power on the digital adjustable spanner.
- Usually press **C** to reset the digital adjustable spanner before using it.



ATTENTION:

If an external force is applied to the spanner during power-on/reset or wake up period, an initial torque offset will exist in the memory.





ACTIVATION DURING SLEEP MODE

- The spanner will auto sleep after about 5 minutes idle for power saving. Press  to wake up the spanner during the sleep mode.

CAUTIONS:

During communication period (`send` appears), the sleep function is disabled.

RESETTING THE SPANNER

- Press   together will reset the spanner.
- If the spanner does not function normally, Press   together to reset the spanner.

LOW BATTERY VOLTAGE PROTECTION

- If the battery serial voltage is in low voltage status, the wrench will display a battery symbol and then turn off after a while.



SETUP

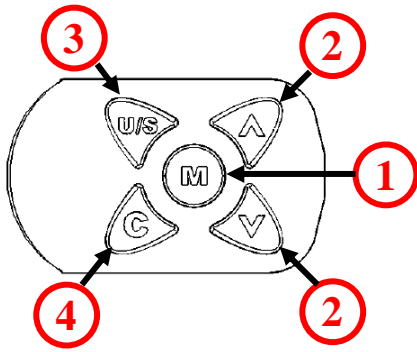

- ① Pre-setting No.
- ② Up/Down Button
- ③ Unit Selection/Setting
- ④ Power On/Clear

STEP 1: PRE-SETTING NO.

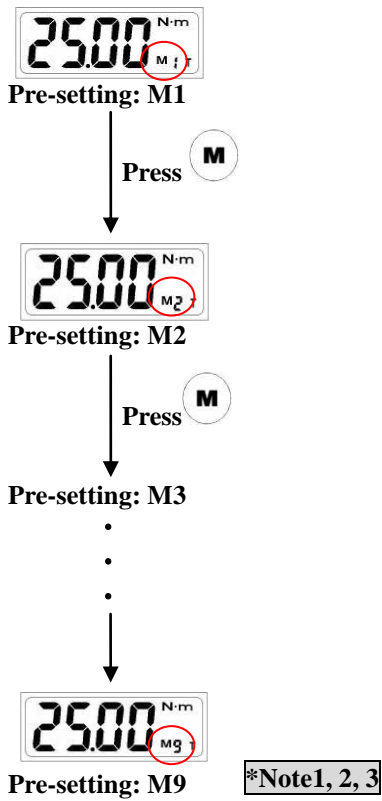

Note:

1. If **Er0** is appeared, that means this spanner has ever been applied more than 110% of torque of the spec.
2. The maximum capacity for "Pre-setting No." is 9 sets.
3. The "Pre-setting No." is cyclic.

STEP 2: UNIT SELECTION

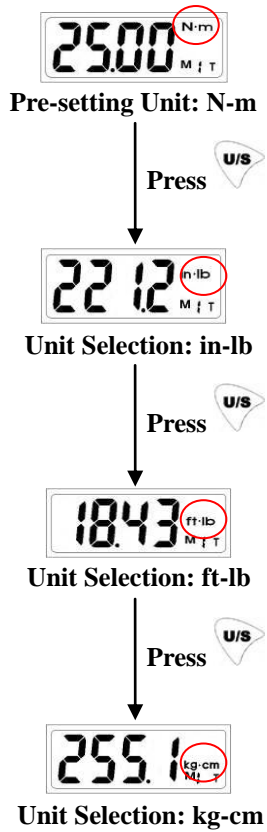

STEP 3: SET TORQUE VALUE

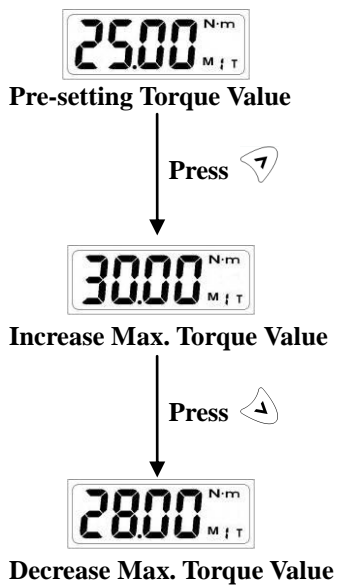

Note:

1. The “Unit Selection” is cyclic.

STEP 4: PEAK HOLD /TRACK MODE SELECTION

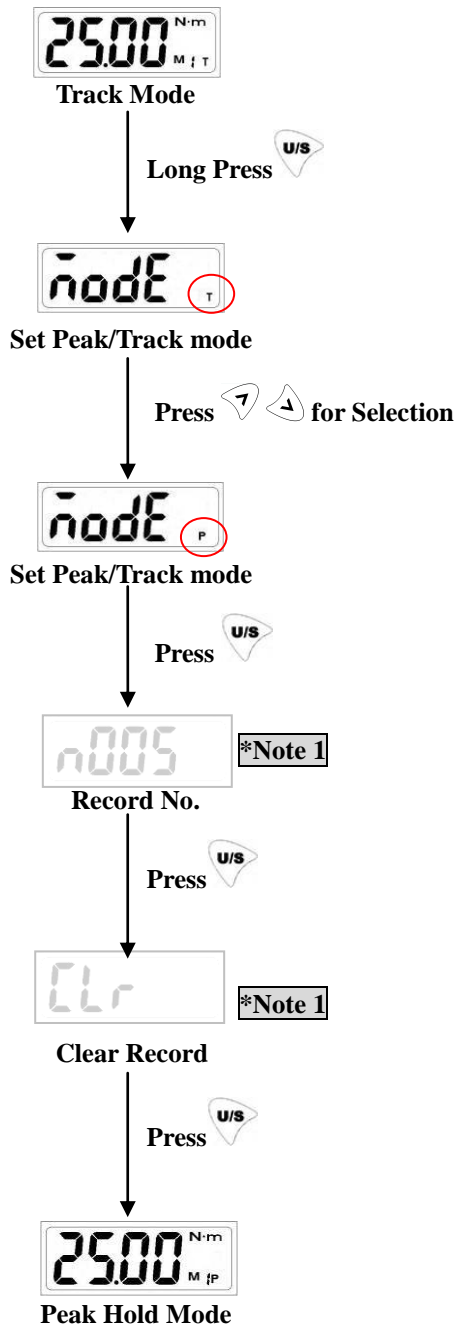

Note:

1. Please skip this procedure and continue to the next step.

TRACK MODE OPERATION

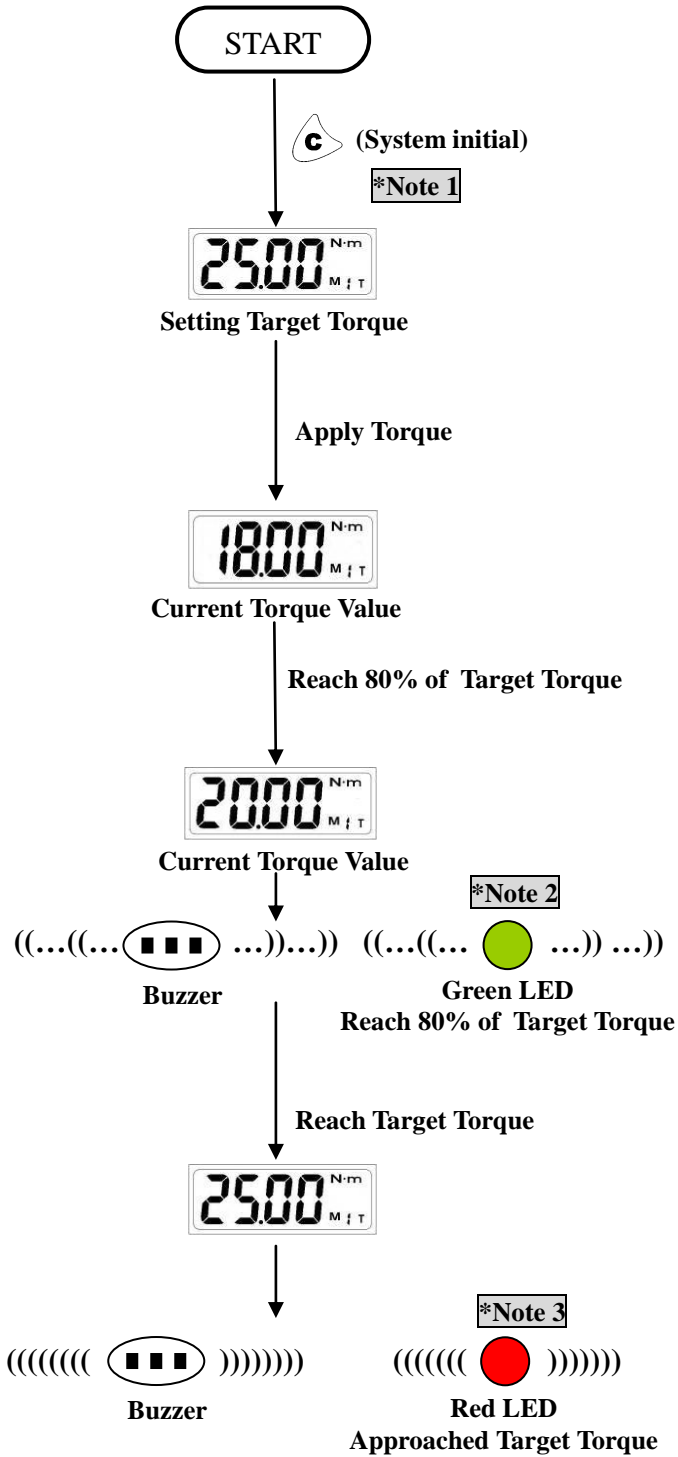

 **Note:**

- If **Er0** is appeared, that means this wrench has ever been applied more than 110% of torque of the spec.
- The green LED will be on for 80%, 85%, 90%, 95% and 97.5% of target torque.
- When reaching the target torque, the green and red LED will be on at the same time.

PEAK HOLD MODE OPERATION

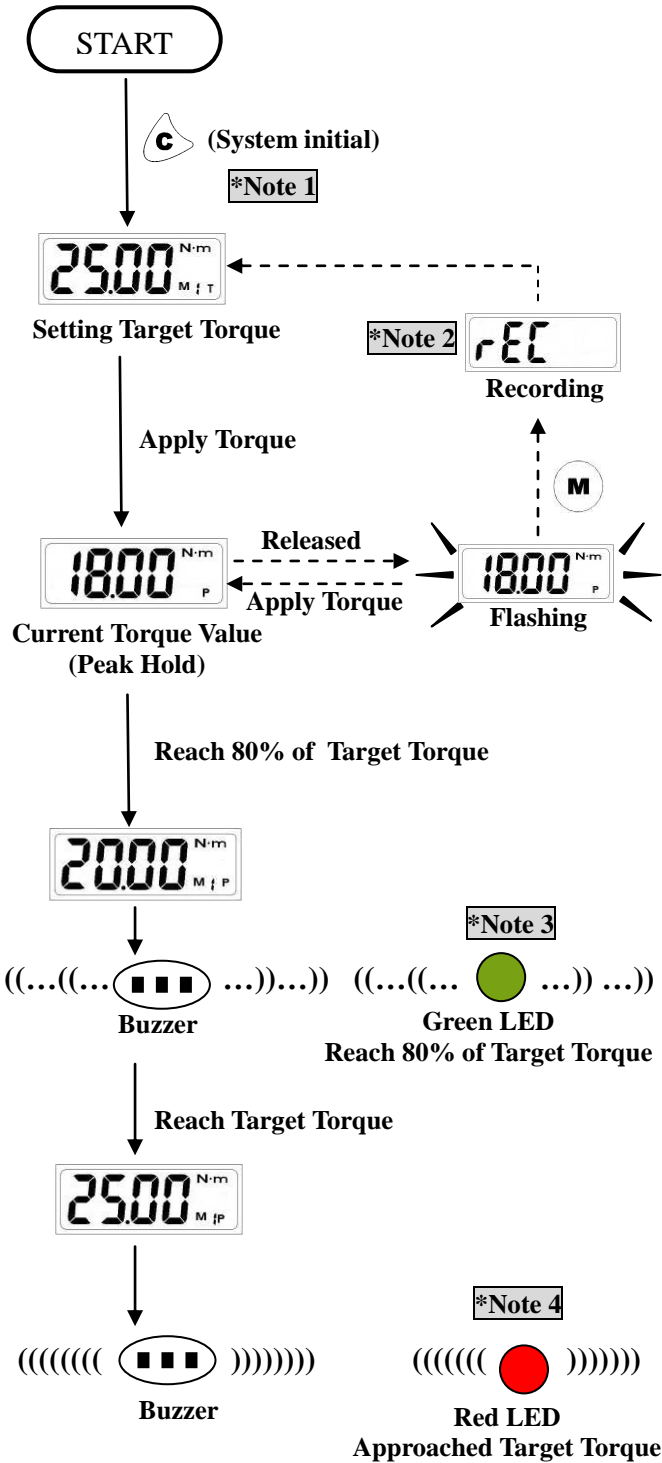

!

Note:

1. If **Er0** is appeared, that means this wrench has ever been applied more than 110% of torque of the spec
2. If **Full** is appeared, that means the wrench's memory is full and the next value record can not be written in. Please refer the "Peak Hold Mode Recorded Value Review" section to clear the memory records.
3. The green LED will be on for 80%, 85%, 90%, 95% and 97.5% of target torque.
4. When reaching the target torque, the green and red LED will be on at the same time.

Peak Hold Mode Recorded Value Review

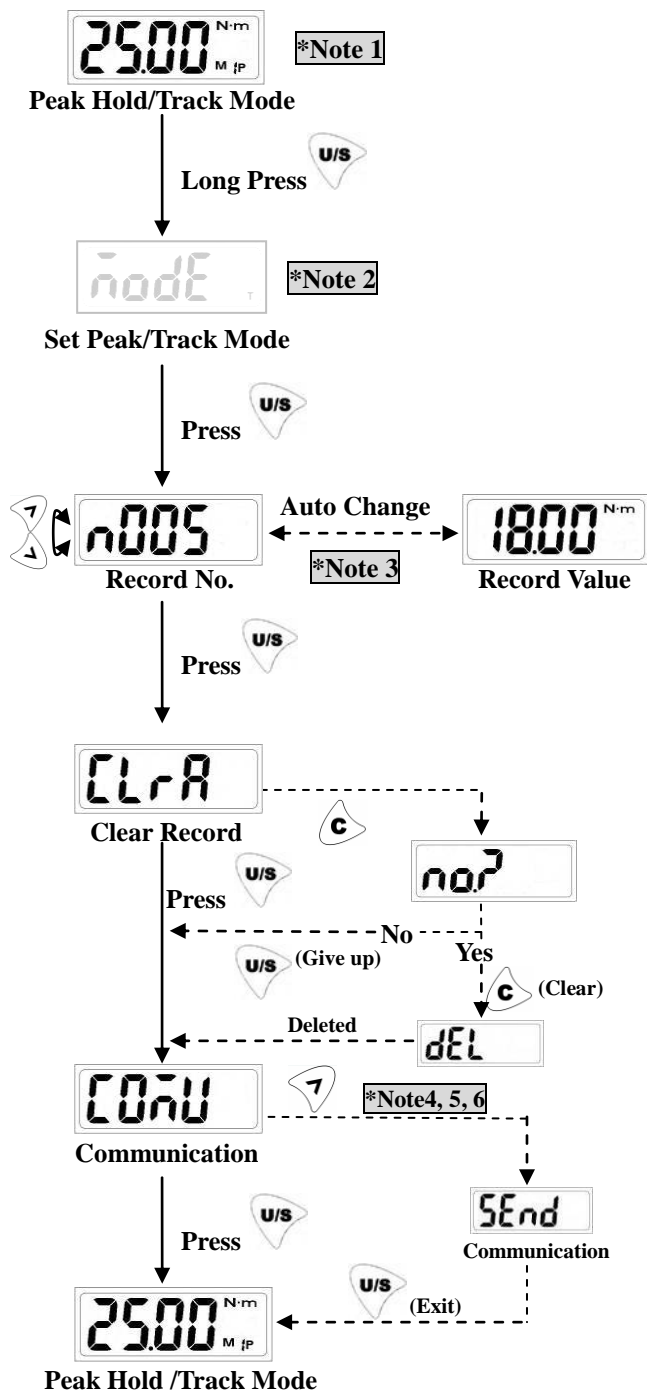

Note:

1. The “Peak Hold” mode recorded value review also can be operated from “Track” mode operation.
2. If you operate in the “Peak Hold” mode, the display will show `none` and please go to next step.
3. If the record is empty, it will show `none`.
4. This function is not supported on all type of models.
5. Communication mode is for uploading record data to PC.
6. Communication mode is also for calibration of torque spanner.
Please contact your local dealer for more information.

COMMUNICATION



Precaution:

1. **Communication function is only supported on some models. Check the model no. and its specification before using communication function.**
2. **Do not insert the plug of communication cable into torque wrench that does not support communication function.**

CONNECTING COMMUNICATION CABLE

- Turn off power and then connect the accessory cable between the COM port of PC and spanner.

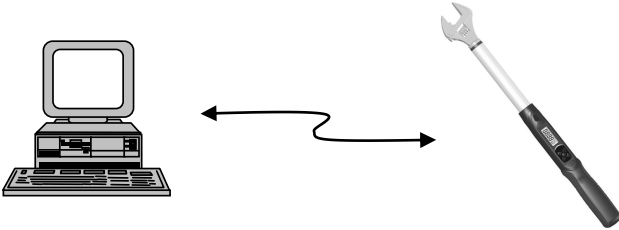

UPLOADING RECORD DATA

- Make sure the connection between PC and spanner is normal.
- Press **C** **7** together to reset the spanner.
- Change the spanner operation mode to “**Send**”.
(Refer to “Peak Hold Mode Recorded Value Review” section)
- Use PC to start the uploader program.
- In uploader program, first select the correct COM port No.
- Next, select the file path to save the uploaded data.
- Finally, press “upload” button to transmit the torque records to PC.
- The uploaded data is then shown on the column and saved in the *.csv file. Use Microsoft Excel to view *.csv file.



CAUTIONS:

Refer to the uploader program user guide for the detail operations.

MAINTENANCE AND STORAGE

ATTENTION:

One-year periodic recalibration is necessary to maintain accuracy.
Please contact your local dealer for calibrations.

CAUTION:



- 1. Over-torque (110% of Max. torque range) could cause breakage or lose accuracy.**
2. Do not shake violently or drop wrench.
3. Do not use this wrench as a hammer.
4. Do not leave this wrench in any place exposed to excessive heat, humidity, or direct sunlight.
5. Do not use this apparatus in water.(not waterproof)
6. If the wrench gets wet, wipe it with a dry towel as soon as possible. The salt in seawater can be especially damaging.
7. Do not use organic solvents, such as alcohol or paint thinner when cleaning the wrench.
8. Keep this wrench away from magnets.
9. Do not expose this wrench to dust or sand as this could cause serious damage.
10. Do not apply excessive force to the LCD panel.
11. Apply torque slowly and graspe the center of the handle. Do not apply load to the end of handle.

BATTERY MAINTENANCE

1. When the spanner is not used for an extended period of time, remove the battery.
2. Keep a spare battery on hand when going on a long trip or to cold areas.
3. Do not mix battery types or combine used batteries with new ones.
4. Sweat, oil and water can prevent a battery's terminal from making electrical contact. To avoid this, wipe both terminals before loading a battery.
5. Dispose of batteries in a designated disposal area. Do not throw batteries into a fire.

Rev. : DAW 1.1