

Compression Load Cell

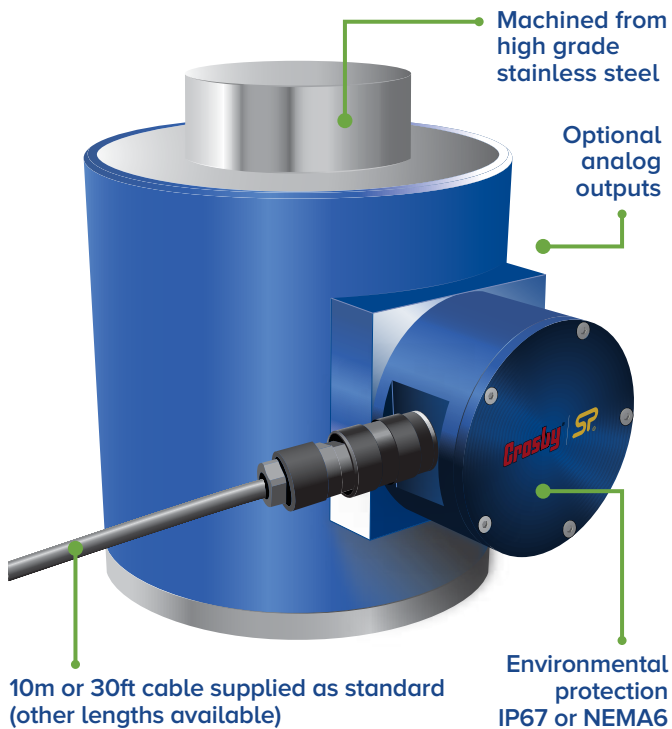

Features and benefits:

- Compact size
- Environmentally sealed to IP67 or NEMA6
- Optional analogue outputs
- Stainless steel element
- High accuracy
- Lightweight
- Unrivalled resolution
- 10m or 30ft cable supplied as standard (other lengths available)
- Custom versions available
- Design validated by F.E.A.



Requires connection to Crosby|Straightpoint's Handheld plus (HHP) or External Amplifier range (SA-3420) that can be configured to provide outputs such as 4-20mA, 0-10v, 0-5v for PLC or data logger integration.

Manufactured in ranges from 5te to 1000te - other capacities available on application.

Straightpoint compression load cells are manufactured to the same stringent standards as all Straightpoint products.

The bodies are machined from high grade stainless steel, offering excellent strength and anti-corrosion properties. Compression load cells can be supplied with optional loadcaps to protect objects being tested.

The compact lightweight design provides ease of use and superior portability, allowing Straightpoint compression load cells to be used in a broad range of industries including mining,

energy, defence, heavy rigging, shipping and general transportation sectors.

Utilising the same advanced microprocessor based electronics as all Straightpoint products, Straightpoint's compression load cells benefit from high sampling rates, extreme resistance to industrial level noise and unprecedented stability.

This high stability gives this product over 5,000 divisions and the highest standard resolution of any high-capacity compression load cell on the market today.

Like all Straightpoint products, Straightpoint compression load cells offer robust construction, advanced electronics, industry leading resolution and accuracy - all at a cost-effective, affordable price.

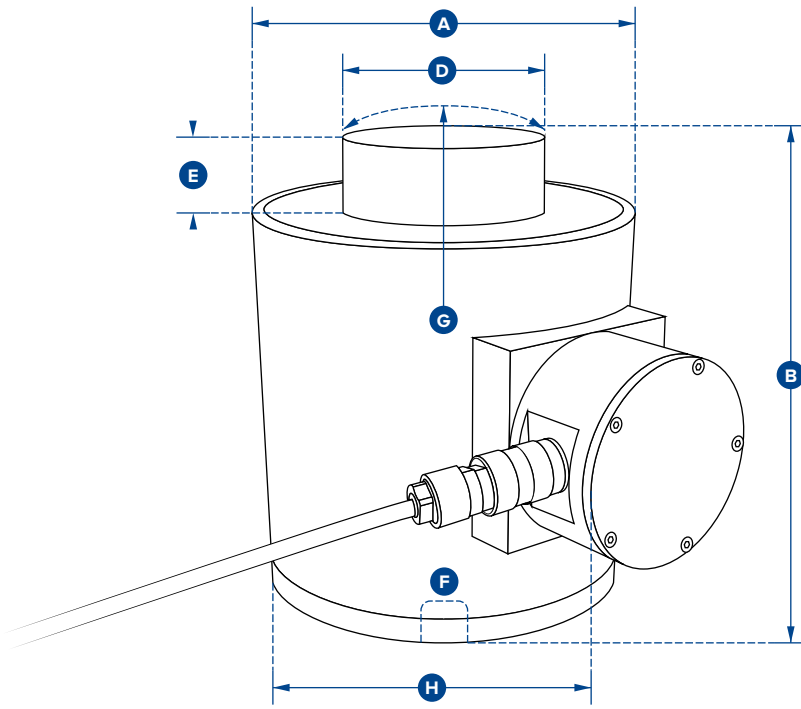

Part Numbers									
SP	NI5TC	NI10TC	NI25TC	NI50TC	NI100TC	NI150TC	NI300TC	NI500TC	NI1000TC
Crosby	2789063	2789062	2789065	2789067	2789061	2789063	2789064	2789066	2789275
Capacity	5te 11000lb	10te 22000lb	25te 55000lb	50te 110000lb	100te 220000lb	150te 330000	300te 660000lb	500te 1100000lb	1000te 2200000lb
Resolution	0.001te 2lb	0.002te 5lb	0.005te 10lb	0.01te 20lb	0.05te 100lb	0.05te 100lb	0.1te 200lb	0.2te 500lb	0.5te 1000lb
Units	tonne								
	lb								
Weight	6.2kg 13.64lb	6.2kg 13.64lb	6.2kg 13.64lb	6.2kg 13.64lb	15.5kg 34lb	15.5kg 34lb	65kg 143lb	65kg 143lb	172kg 379lb
Safety Factor	3:1								
Operating Temp	-10°C to +50°C 14°F to 122°F								
Accuracy	±0.1% of full scale								
Protection	IP67 NEMA6								
Dimension ØA	100 3.94"	100 3.94"	100 3.94"	100 3.94"	152 5.98"	152 5.98"	185 7.28"	185 7.28"	362 14.25"
Dimension B	127 5.00"	127 5.00"	127 5.00"	127 5.00"	184 7.24"	184 7.24"	300 11.81"	300 11.81"	310 12.20"
Dimension ØD	59 2.32"	59 2.32"	59 2.32"	59 2.32"	80 3.15"	80 3.15"	155 6.10"	155 6.10"	270 10.63"
Dimension E	16 0.63"	16 0.63"	16 0.63"	16 0.51"	26 1.02"	26 1.02"	27.5 1.08"	27.5 1.08"	40 1.57"
Dimension F	M18 x 2.5 M18 x 2.5	M18 x 2.5 M18 x 2.5	M18 x 2.5 M18 x 2.5	M20 x 2.5 M20 x 2.5	M20 x 2.5 M20 x 2.5	M20 x 2.5 M20 x 2.5	M20 x 2.5 M20 x 2.5	M20 x 2.5 M20 x 2.5	M30 x 3.5 M30 x 3.5
Dimension G	152 5.98"	152 5.98"	152 5.98"	152 5.98"	432 17.01"	432 17.01"	432 17.01"	432 17.01"	950 37.40"
Dimension H	158 6.22"	158 6.22"	158 6.22"	158 6.22"	204 8.03"	204 8.03"	237 8.03"	237 8.03"	416 16.38"