

---

# MODEL ETX/ETPX

---

## TENSION METERS

---



---

## Operating Manual

---

---

---

---

## TABLE OF CONTENTS

<b>1.0 Introduction</b> .....	2
1.1 Delivery	
1.2 Precautions	
1.3 Verificaton interval	
<b>2.0 Overview</b> .....	3
2.1 Operating elements	
2.2 Removing the Filament Guide	
2.3 Mounting the Filament Guide	
2.4 Display elements	
<b>3.0 Setup</b> .....	7
3.1 Charging the Battery	
3.2 Switching the tension meter on	
3.3 Switching the tension meter off	
<b>4.0 Tension meter settings</b> .....	8
4.1 Material menu.	
4.2 Password	
4.3 Factory reset	
<b>5.0 Operating procedure</b> .....	10
5.1 Zero adjustment of the measurement position	
5.2 Inserting and removing material to be measured	
5.3 Damping	
5.4 Using the alarm function	
5.5 Cal. Adjustment	
<b>6.0 Creating a material characteristic</b> .....	13
6.1 Setup for calibration	
6.2 Calibration procedure	
6.3 Verifying the calibration	
<b>7.0 Memory functions</b> .....	17
7.1 Selecting the memory mode	
7.2 Memory Mode S – <i>Standard</i>	
7.3 Memory Mode C	
7.4 Memory Mode F	
7.5 Memory Mode H	
7.6 Memory Mode D	
<b>8.0 PC Communications (USB interface)</b> .....	28
8.1 Installing the USB Driver	
8.2 The TENSION INSPECT 3 program	
8.3 Terminal program	
<b>9.0 Service and maintenance</b> .....	29
8.1 Roller	
8.2 Replacing the Rollers/Ceramic Pins	
<b>10.0 Specifications</b> .....	32
<b>11.0 Warranty</b> .....	

---

---

---

## 1.0 INTRODUCTION

The Checkline ETX/ETPX tension meters accurately measure tension on fine wires, yarns and fibers. Rollers or ceramic pins are mounted at the end of long “fingers” permitting the user to measure tension with limited access space or when several lines are closely spaced such as on a warp sheet.

Features include color, backlight TFT-display with 3 different displays modes: numeric, numeric with live bargraph, numeric with graph (time vs tension). The display auto rotates in 90° steps for optimal visibility regardless of the position of the tension meter.

### 1.1 Delivery

ET Series gauges are delivered as a complete kit including tension meter, built-in rechargeable battery and USB/AC adapter with country adapters (EU, US, UK, AUS/NZ) and operating instructions all supplied in a foam-fitted carrying case.

Optional: NIST-Traceable Calibration Certification.



### 1.2 Precautions



The device must not be operated in potential explosive areas and must not come into contact with aggressive substances.

Tensions that exceed the tension range of the instrument by more than 100% may cause permanent damage to the measuring spring and must be avoided under any circumstances.

**For cleaning the unit** do not use any aggressive solvents such as trichloroethylene or similar chemicals. No warranty or liability shall be accepted for damage resulting from improper cleaning.

### 1.3 Verification interval

The question of finding the right frequency of calibration accuracy verification depends on several different factors: Operating time and load of the tension meter, tolerance band defined by the customer, changes to the tolerance band compared to previous calibrations

Therefore, the interval between verifications of calibration must be determined by the user's Quality Assurance Department, based on the user's experience. Assuming normal operating time and load as well as careful handling of the tension meter, we recommend a verification interval of one year.

---

---

---

## 2.0 OVERVIEW

### 2.1 Operating elements

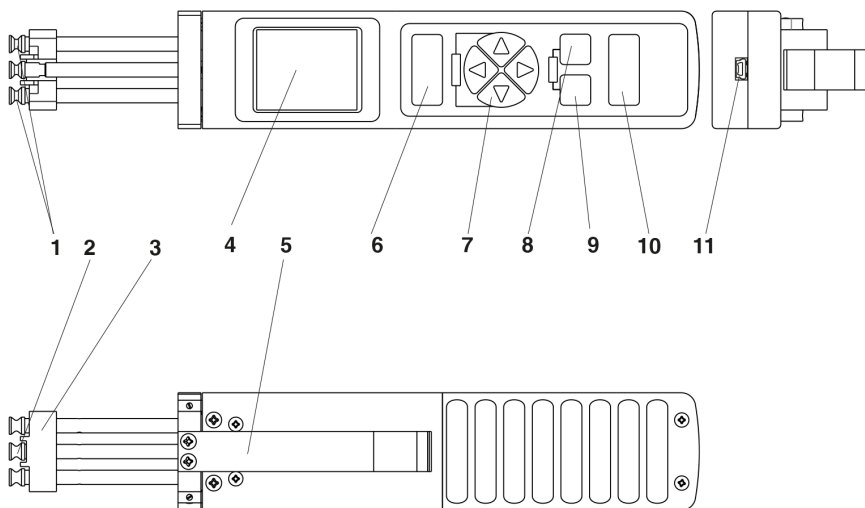

- |                            |                           |
|----------------------------|---------------------------|
| <b>1</b> Guide rollers     | <b>7</b> Arrow key        |
| <b>2</b> Measuring rollers | <b>8</b> SET/DAMP key     |
| <b>3</b> Filament guide    | <b>9</b> ESC/EXIT key     |
| <b>4</b> Display           | <b>10</b> POWER/ZERO key  |
| <b>5</b> Lever             | <b>11</b> Power connector |
| <b>6</b> MEMORY key        |                           |

---

---

## 2.2 Removing the Filament Guide (see also section 8.0)

The tension meter is supplied with a filament guide for fast and easy material acquisition. For application in hard-to-reach areas with limited access space, you can remove the filament guide.

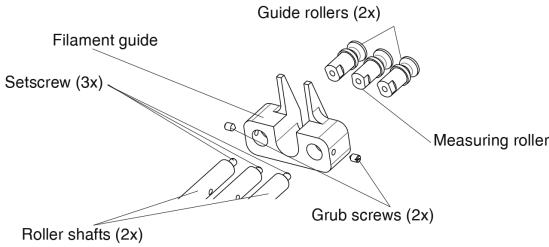

1. Loosen the grub screws (2x) with the supplied screwdriver (blade width 1.5 mm).
2. Unscrew and remove the guide rollers (2x) with the supplied open end wrench (jaw width 4 mm).
3. Slip the filament guide off the roller shafts.
4. Screw the guide rollers (2x) back on to the roller shafts and carefully tighten them with the supplied open end wrench (jaw width 4 mm) until hand-tight.

## 2.3 Mounting the Filament Guide

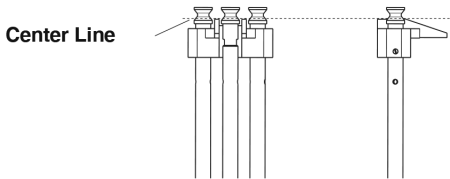

1. Unscrew and remove the guide rollers (2x) with the supplied open end wrench (jaw width 4 mm).
2. Slip the filament guide on to the roller shafts.
3. Screw the guide rollers (2x) back on to the roller shafts and carefully tighten them with the supplied open end wrench (jaw width 4 mm) until hand-tight.
4. Push the filament guide forward far enough to ensure that the rollers do not rub against the filament guide and that the process material can slide unhindered from the filament guide into the roller grooves (see figure above, center line).
5. Carefully tighten the grub screws (2x) with the supplied screwdriver until hand-tight.

---

---

---

## 2.4 Display elements

### Numeric Display

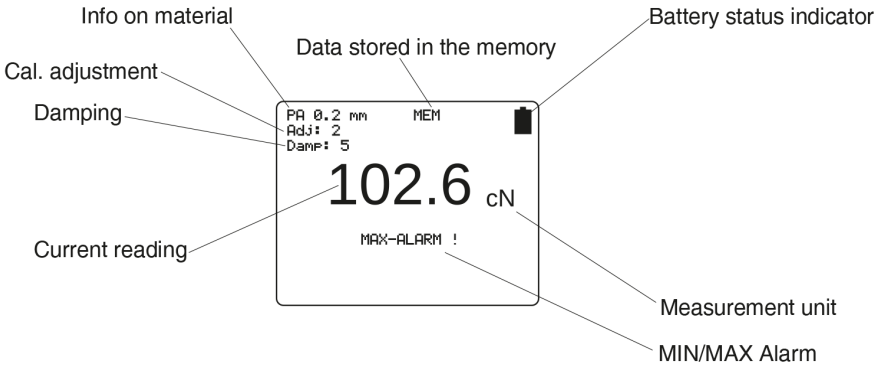

### Display with Bar Graph

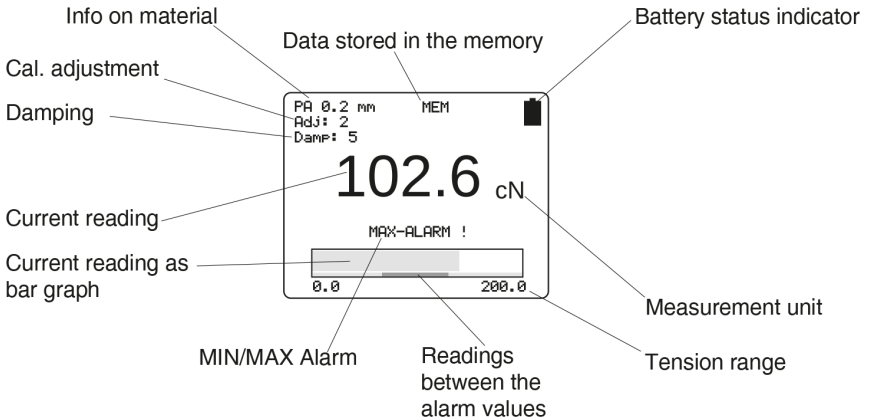

---

---

---

## Display with Bar Graph

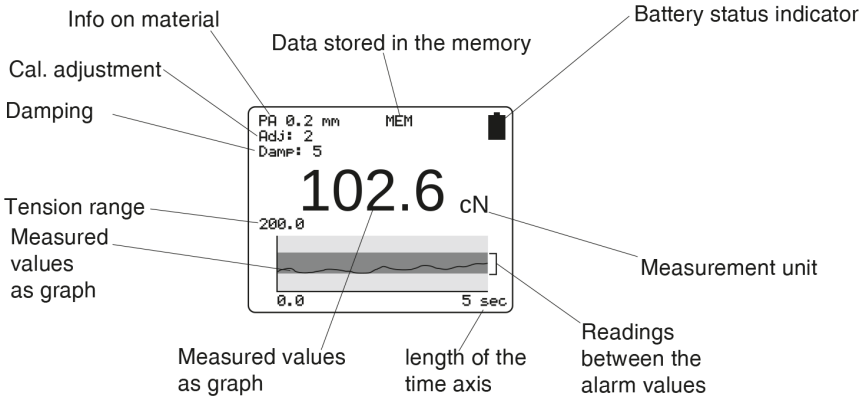

**NOTE:** The Y-axis can be scaled with the ▲ and ▼ buttons.  
3 Scalings: total measuring range, set limits range plus approx. 1/3 of MAX-alarm value and minus approx. 1/3 of MIN-alarm value, if limit values are entered and the damping is not activated.

With the ◀ or ▶ button the X-axis can be scaled.  
The setting range is 2 to 60 sec.

The scaling can also be changed during the measurement, whereby values already displayed are deleted when the X-axis is changed.

---

---

---

## 3.0 SETUP

The tension meter is delivered with a built-in rechargeable LiPo battery, which has been charged at the factory. The tension meter can only be switched on if the battery has enough charge. If the instrument does not power up or if the battery level indicator shows a low charge  after power-up, the battery needs to be recharged.



To ensure maximum battery life, avoid discharging it completely or charging it frequently for short periods. The battery should not be stored for an extended period of time when empty. After a maximum storage period of one year, the battery has to be recharged.

### 3.1 Charging the Battery

The battery can only be charged at a temperature between +5 °C and +45 °C.



Before you connect the AC adapter, verify that the supply voltage is correct (100 V – 240 V).

To charge the battery, remove the rubber stopper from the USB interface. Then connect the AC adapter cable to the USB output. The battery can also be charged by connecting the USB cable to a PC. The battery level indicator will be shown full  when the battery is fully charged. The charging time is approx. 3 ½ hours (using the AC adapter).

**NOTE:** Battery overcharging is not possible

### 3.2 Switching the tension meter on

1. Press and hold the  button (for approx. 1 sec.) until the DISPLAY shows the measuring range, the software and hardware versions, e.g. E 1.0, and then “0”.

During startup, the tension meter performs an automatic zero adjustment. If the tension meter does not display zero, perform a manual zero adjustment procedure (see section 5.1).

**NOTE:** Holding the  button makes the display freeze so that you can read the measuring range and the software and hardware versions.



While switching on the tension meter, make sure not to move it. Otherwise, the automatic zero adjustment will be faulty.

### 3.3 Switching the tension meter off

*Automatic switch-off (if enabled):* After an idle period of 3 minutes, the tension meter switches off.

*Manual switch-off:* Press and hold the  button for 5 seconds.



## 4.0 TENSION METER SETTINGS

1. Press the **ESC** **EXIT** and **SET** **DAMP** buttons simultaneously to access the main menu.
2. The **▲** and **▼** buttons can be used to select the various menu items of the main menu, the submenus and the settings menus.
3. Press the **▶** button to open the selected menu; by pressing the **◀** or **ESC** **EXIT** button you can close the menu without saving changes.
4. In menus with multi-digit fields (e.g. date) use the **◀** and **▶** buttons to move forward and backward between digits.
5. Press the **SET** **DAMP** button to save the settings and exit the settings menu or press the button to exit the current menu without saving.
6. To exit the main menu press the **ESC** **EXIT** button.

Main Menu	Submenu	Settings Menu	Description
Material	[1] to [4]		Chapter 3.4.1 Material-Set-up
Cal. Adjustment	–	[- 10 %] - [+ 10 %]	Chapter 3.5.6
Display Chapter 3.2	–	[numeric] [Bargraph] [Graphic]	<ul style="list-style-type: none"> <li>• Measured value displayed as number and alarm monitoring</li> <li>• Measured value displayed as number, bar graph trend display and alarm monitoring</li> <li>• Measured value displayed as graphical trend,</li> </ul>
Alarms	–	[ON], [OFF]	Activate/deactivate the alarm for all calibrations. The alarm of a material characteristic is only active if the [Alarm] menu item in Material Setup is activated as well.
Display Settings	Backlight	[ON], [OFF]	Switch the display light on or off. With the AUTO setting, the light switches on and off automatically depending on the ambient light.
	Brightness	[1], [2], [3]	Set the display brightness.
	Colortheme	[white], [black]	A white or black display background can be adjusted
	Screen Rotation	0°, [90°], [180°], [270°], [AUTO]	Set the display orientation to be fixed or to automatically adapt to the current orientation of the device.
System Settings	Tension Unit	[cN], [g], [lb], [N],	Set the measurement unit. The available units may vary depending on the measuring range of the device.
	Auto Power Off	[ON], [OFF],	Toggle the Auto Power off function on and off.
	Language	[EN], [DE]	Select between the english and german user language.
	Date/Time	[Time], [Date],[Timeformat]	Set the time, date, and date/time format.
	Password	[0], [1], [2], [3]	Chapter 3.4.2
	Factory Reset		Reset to the factory settings.

Factory Settings are illustrated in bold

---

---

---

## 4.1 Material menu

In the material menu you can make the settings for the selected material characteristics and perform the calibration. To perform the calibration, the weights for the selected calibration points must be available.

Material Setup	Submenu	Settings Menu	Description
No. of the characteristic material-curve 1 - 4	–	[character] [numbers] [special character]	to enter a name for the selected material characteristic. The name can also be adjusted by using the provided software
Damping	–	[1] – [9]; [5]	Section 5.3
Alarms	–	[ON], [OFF]	To activate or deactivate the alarm
High Limit	–	[0000], [9999]	If the set limit value is exceeded, the display reads MAX-ALARM.
Low Limit	–	[0000], [9999]	If the value falls below the set limitvalue, the display reads MIN-ALARM.
Calibration Chapter 3.6.2	Start		To perform a calibration, follow the instructions shown on the display.
	Cal Points	between [5%] and [90 %] of the tension range	Set three calibration points for which a calibration should be performed.
	Weight	[cN], [g]	Set the unit of the calibration weights used.

Factory Settings are illustrated in bold

## 4.2 Password

By setting a password, you can block the access to some menu parts for unauthorized users. There are 3 protection levels:

- 0 All menus are accessible (Factory setting)
- 1 The system setting menu is locked
- 2 The material, system setting, memory setting and cal. adjustment menus are locked
- 3 All menus are locked.

### To apply the password protection

1. Select the menu password.
2. Insert a password and choose a protection level.
3. Exit the main menu, to apply the password protection.

**NOTE:** The factory setted password is 0000. If you forgot the password, please contact the factory to request the master password.

## 4.3 Factory reset

A factory reset resets the tension meter to its original manufacturer settings. This procedure will delete all settings, including any customer-defined material characteristics (calibrations); the factory calibration, however, will be kept.



**WARNING:** Customer calibrations will be deleted.

---

---

---

## 5.0 OPERATION PROCEDURES

### Requirements:

1. Switch the tension meter on (section 3.2)
2. Define the required tension meter settings (section 4.0)
3. Select the desired material characteristic (section 4.1)
4. Bring the tension meter into the desired measuring position and carry out a zero adjustment as described in section 5.1, if required.



### 5.1 Zero adjustment of the measurement position

Each time the measurement position is changed, the tension meter will automatically perform a zero adjustment.

If the tension meter does not display zero in its measuring position, perform a manual zero adjustment procedure. For this purpose, no material to be measured must have been inserted yet!

#### To carry out zero adjustment:

1. Switch on the tension meter
2. Bring the tension meter into the desired measuring position and make sure not to move it.
3. Press the  button.

The Display momentarily shows  and then switches to . The tension meter is now adjusted to its new measuring position and ready to take measurements.

### 5.2 Inserting and removing material to be measured

#### Inserting the material to be measured:

1. Press the lever to tilt the outer guide rollers sideways.
2. Thread the material to be measured through the measuring and guide rollers (filament guide).
3. Slowly release pressure on the lever until the guide rollers return to their original position.

**NOTE:** It is important to assure that the material to be measured runs smoothly between the measuring and guide rollers.

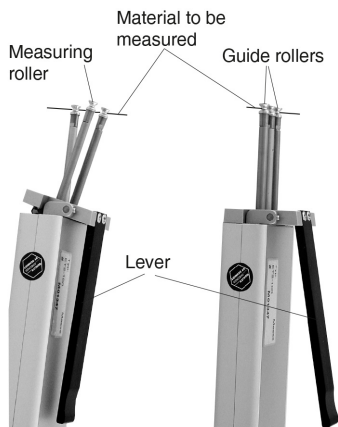

---

---

## Measuring:

The display now shows the measured tension values.



### To remove the material to be measured:

1. Press the lever and remove the material to be measured.
2. Slowly release pressure on the lever until the guide rollers return to their original position.

## 5.3 Damping

This feature is used for tensions that vary strongly

In the Damping menu, you can specify separate damping factors for each material characteristic.

1. Back in the display mode, press the  button to activate or deactivate the damping function. This is recommended if the displayed values vary strongly.
2. Press the  button to increase the damping value or the  button to decrease it.



Changes made to the damping factor using the arrow keys are not saved permanently in the material characteristic. If you disable the damping feature or select a different material characteristic, the damping factor will be reset to the value originally saved for the material characteristic.

The factory setting for the damping factor is 5. The average shown on the display is calculated as follows:

The factory setting for the damping factor is 5. The average shown on the display is calculated as follows:

$$\frac{5 \text{ old measured values} + 4 \text{ new measured values}}{9}$$

Damping can be changed in 9 steps from 01 = low damping

$$\frac{1 \text{ old measured values} + 8 \text{ new measured values}}{9}$$

to 9 = high damping

$$\frac{8 \text{ old measured values} + 1 \text{ new measured values}}{9}$$

---

---

## 5.4 Using the alarm function

1. In the Material Setup menu, make sure that the MIN and MAX limit values have been set for each material characteristic.
2. The limit value alarm has to be enabled in the main menu.

## 5.5 Cal. Adjustment

By performing a calibration adjustment, you can adjust a material characteristic calibrated for a particular material to a different material or diameter without creating a new material characteristic

### Requirements:

1. Prepare the measuring setup as shown in figure below.
2. Select the desired material characteristic (section 5.2).
3. Move the tension meter into the desired measuring position and carry out a zero adjustment, if required.

### Adjusting:

1. Select the Cal. Adjustment menu item from the main menu (see figure below)
2. Insert the material to be measured (section 5.2) and push the thumbpiece into the measuring position.
3. Press the ▲ or ▼ key to perform the calibration adjustment until the value on the display corresponds to the weight suspended to the material. The adjustment can be performed in 1% steps within the range from +10% to -1%.
4. Press the  button to save the determined value.

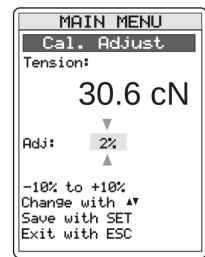
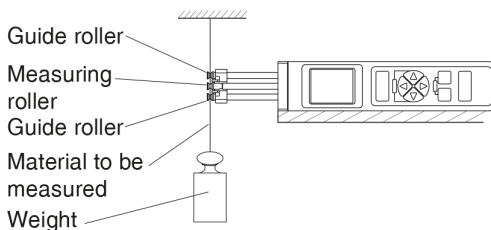

**NOTE:** Please note that this is a general value. So determine it separately for each material characteristic and note it down for later reference. It is not possible to save it per material characteristic. To disable calibration adjustment, reset the value to 0% in the Cal. Adjustment menu.



The calibration adjustment must be conducted with the weight unit that is adjusted in the menu tension unit and carried out with weights corresponding to the chosen unit.

---

---

## 6.0 CREATING A MATERIAL CHARACTERISTIC

The material and diameter is given in chapter 2. Factory calibrations using customer supplied materials follow the same procedure. In this case, however, the calibration on factory material is omitted. Fig. A shows a measuring setup for the dynamic calibration, while fig. B shows a measuring setup for the static calibration.

**NOTE:** The material characteristics has been preset in the factory and cannot be overwritten. For these material characteristics, you can only change the damping factor, the alarm function setting, and the limit values.

### 6.1 Setup for calibration

#### Dynamic Calibration (A)

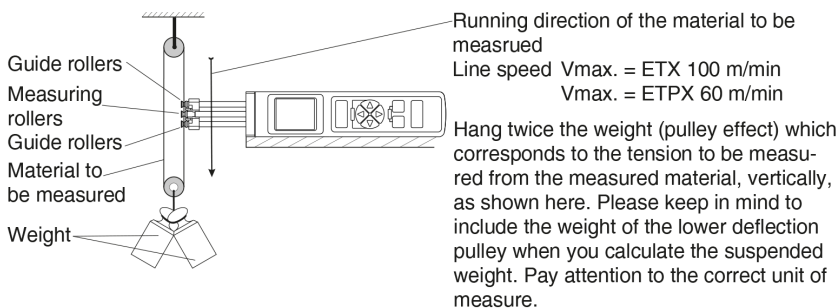

Hang twice the weight (pulley effect) which corresponds to the tension to be measured from the measured material, vertically, as shown here. Please keep in mind to include the weight of the lower deflection pulley when you calculate the suspended weight.

#### Static Calibration (B)

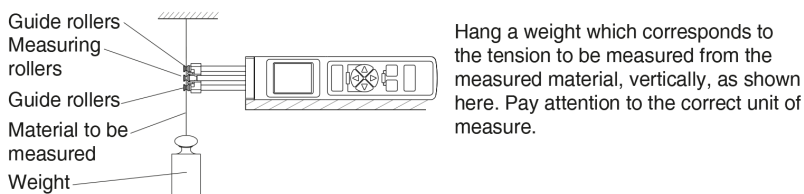

**NOTE:** The tension meter has been calibrated dynamically according to the factory procedure. Therefore, differences may occur between static and dynamic readings.

---

---

## 6.2 Calibration procedure

Calibrations of the tension meter are performed according to the factory procedure using weights that correspond to 10%, 50%, and 90% of the measuring range. In 95% of all industrial applications, the factory calibration has been proven to provide the best results. In particular, it is suitable for comparative purposes. If the material to be measured differs significantly from the factory calibration material in material type, diameter, rigidity, shape, etc., we recommend to perform a calibration using customer-supplied material. In addition to the factory-preset material, you can save up to 3 additional materials.

### Calibration Units and Calibration Points

The device can be calibrated in centinewton (cN) or gram (g). Although the unit of the calibration weights has to correspond with the unit chosen in the menu calibration.

For the calibration of the tension meter, three calibration weights are used. For example, if you select 10%, 40%, 70% for the weights for the static calibration must correspond to 10%, 40% and 70%, for the dynamic calibration 20%, 80% und 140% of the measuring range.

In this example, you need the following weights for the ETX-100:

Static calibration in Newton: 10 cN, 40 cN, and 70 cN

Static calibration in Gram: 10 g, 40 g, and 70 g

Dynamic calibration in Newton: 20 cN, 80 cN, and 140 cN

Dynamic calibration in Gram: 20 g, 80 g, and 140 g

**NOTE:** The measured values are displayed in the unit set in the Settings menu, independent from the unit that was used to calibrate the material characteristic. So that they are available when you verify the calibration later or repeat the calibration after a factory reset. For example

Material to be Measured	Unit	Calibration points
Yarn	cN	5%, 50%, 90%

### To perform the calibration procedure

1. Select a new material or edit an existing one (by re-entering the values) from the material menu.
2. Enter a designation (you can use the software supplied with the tension meter alternatively).

**NOTE:** While performing the calibration, the tension meter must be fixed in such a way that the material to be measured runs smoothly between the guide rollers and the measuring roller.

The display gives detailed information on the calibration.



Step 1. Set the calibration points and weights, e.g. in Newton using the calibration points 10%, 40%, and 70 % of full scale

**Start:** Select the Start menu item.

Alternative calibration points: 5%, 45%, 90% 10%, 50%, 90 %  
5 %, 50%, 90% 10 %, 40%, 70 %  
10%, 45%, 90%

We recommend to use the 10%, 50%, 90% setting for an initial calibration. If the measured values are not accurate enough when you check the calibration, repeat the calibration using other calibration points. We recommend that you align the middle of the tension range to be measured with the middle calibration point.



Step 2. Perform a zero adjustment with the tension meter in its measuring position



Step 3: Calibrate calibration point 1 Insert material to be measured



Step 4: Calibrate calibration point 2



Step 5: Calibrate calibration point 3

**NOTE:** Once you have completed the calibration, make sure to verify it as described in sectio 6.3. In case of a large deviation, repeat the calibration or select different calibration points.



---

---

### 6.3 Verifying the calibration

When verifying the calibration, make sure to select the same material, calibration position and calibration points as used for creating the associated material characteristic. Otherwise, the precision of the measurements will not be sufficient.

The tension meter has been calibrated on material 1 according our factory procedure for a vertical material path and cannot be deleted or overwritten. The diameter and material is given in chapter 2. Calibrations of the tension meter are performed according to the factory procedure using weights that correspond to 10%, 50% and 90% of the measuring range.

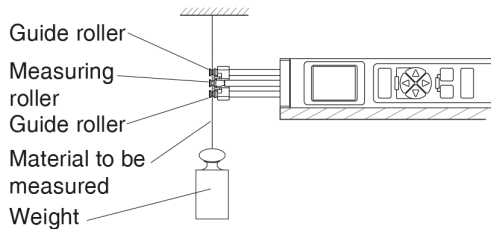

1. Attach a weight vertically to the material to be measured that corresponds to the tension to be measured (make sure to select the correct unit). The weight must hang freely. (Always use a fresh portion of the material to be measured.)
2. Insert the material as described in chapter 5.2.



*Do not let the lever snap back as this could affect the calibration and damage the instrument.*

3. Before verifying the calibration, move the instrument slowly up and down to compensate for any mechanical friction losses and thus ensure repeatability of the measurements.
4. The tension value shown on the display should be equal to the mass of the suspended weight.

**NOTE:** If the verification of the calibration shows a deviation beyond the allowable tolerance so that reliable operation is no longer possible, the instrument needs to be re-calibrated or returned to the factory for repair.

---

---

## 7.0 MEMORY FUNCTIONS

The tension meter is delivered with 5 different memory modes. You can store up to 999 measurement series at one or more machine positions. The number of storable measurement series is depending from the adjusted memory mode and the selected storage time and will be displayed in the setting menu of the memory mode. The tension meter can store up to 60000 measured values.

All saved measured values and statistic datas can be transferred to a PC (for further processing, e.g. in Excel). For this purpose, use the software supplied with the tension meter.

**Recall of memory:** The display only shows the last measured value, the average, the minimum and maximum measured values, the peaks, the standard deviation and the number of measured values per measurement series.

You can select the desired memory programs from the main menu.

### **Memory Mode S – Standard**

Data is recorded during a user-defined period (min 1 sec, max. 60 min). 2 readings/second will be recorded. The system will only determine and save statistical values.

### **Memory Mode C – Continuous**

Data is recorded during a user-defined period (min. 1 sec, max. 8 hrs 20 min). The system will acquire 2 measured values/sec, determine statistical values, and save them for each measurement series together with the measured values.

### **Memory Mode F – Fast**

Data is recorded during a user-defined period (min. 1 sec, max. 60 sec.). The system will acquire 200 measured values/sec, determine statistical values, and save them for each measurement series together with the measured values.

### **Memory Mode H – Hold, Freeze Display**

The last max. 128 values are saved. In graphical mode, you can freeze the display and thus view the course of the tension values after completion of the measurement. The system will determine statistical values and save them together with the measured values.

### **Memory Mode D – On demand**

Recording single readings by the operator instigation. Statistical values and readings will be saved for only one measurement series.



Changing to another memory mode will delete any saved data. When you select the memory mode, a corresponding message is displayed. The selected memory mode and the saved data will be kept even after switching off the tension meter.

---

---

## 7.1 Selecting the memory mode

### Requirements:

1. The tension meter has been switched on as described in section 3.2.
2. Open the menu by pressing the **ESC** **EXT** and **SET** **DAMP** buttons simultaneously and select Memory Settings.
3. Select the desired memory mode in the user navigation.

**NOTE:** If the memory already contains data, a message will inform you that the data will be deleted.

## 7.2 Memory mode S – Standard

Data recording for a user-set time)

### Saving Data

#### Requirements:

In the main menu, select Memory Settings and then memory mode S.

#### To save the first measurement series:

1. Press the **MEMORY** button to start recording the measured values.
2. While recording is in process, **Rec S** flashes on the display.
3. Once the set time has elapsed, no more data will be saved (the display shows **Mem S**, the memory position and the free memory space).
4. If the **MEMORY** button will be pressed before the set time has elapsed data recording stops and data will automatically be saved.

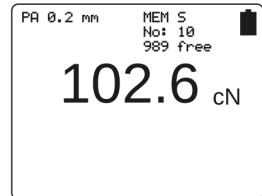

To abort data recording, press the **ESC** **EXT** button. This stops the procedure. No data will be saved.

#### To save more measurement series'

1. Press the **MEMORY** button to start recording the measured values.
2. While recording is in process, **Rec S** flashes on the display.
3. Once the set time has elapsed, no more data will be saved. The display shows **Mem S**, the memory position, and the free memory space.
4. If the **MEMORY** button will be pressed before the set time has elapsed data recording stops and data will automatically be saved.

---

---

## Displaying the saved measured values

1. Press the RECALL ◀ and ▶ buttons simultaneously to display the saved data.
2. The ◀ and ▶ buttons allow you to switch between the various measurement series.
3. The display will only show statistical values:
  - Number of batch (File)
  - Name of the material to be measured
  - Date and time of the measurement series
  - Last reading
  - Average
  - Max.
  - Min.
  - Standard deviation (Std dev)
  - Number of measured values (Records)

## Displaying the saved measured values on a PC



The software Tension Inspect 3 is supplied with the tension meter. It allows you to easily and accurately analyze the saved measured values and export them to an Excel table.

### Sample memory printout

17.10.2018 11:37	ETX-Series-420 100 cN	Unit : cN
Material: PA 0.2 mm		
Start: 11:32:30 17.10.18		
Stop: 11:32:38 17.10.18		
Last: 23.3		
Avg: 23.6		
Max: 24.4		
Min: 21.9		
Std dev: 6		
Peak max: 53.5		
Peak min: 4.5		
HI-Alarm: 85.0		
Lo-Alarm: 15.0		
Records: 16		

## Deleting the saved measured values

If data is saved in the tension meter, the display shows “Mem” and indicates the free memory space.

1. Press the RECALL ◀ and ▶ buttons
2. Then press the  button and confirm with the  button. This clears the memory. This clears the memory.

---

---

### 7.3 Memory mode C

Data is recorded during a user-defined period. The tension meter records 2 measured values/sec.

#### Saving data

##### Requirements:

In the main menu, select Memory Settings and then memory mode C.

##### To save the first measurement series

1. Press the **MEMORY** button to start recording the measured values.
2. While recording is in process, “Rec C” flashes in the display.
3. Once the set time has elapsed, no more data will be saved. The display shows **Mem C**, the memory position and the free memory space.
4. If you press the **MEMORY** button before the set time has elapsed, no more data will be saved. The data is saved automatically. The display shows “**Mem C**”, the memory position and the free memory space.

##### To save more measurement series

1. Press the **MEMORY** button to start recording the measured values.
2. While recording is in process, **Rec C** flashes in the display.

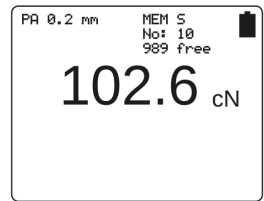

**i** To abort data recording, press the **ESC** button. This deletes the procedure. No data will be saved.

##### To save more measurement series:

1. Press **MEMORY** the button to start recording the measured values.
2. While recording is in process, **Rec C** flashes in the display.

##### Displaying the saved measured values

1. Press the **RECALL** ◀ and ▶ buttons simultaneously to display the saved data.
2. The ◀ and ▶ buttons allow you to switch between the various measurement series.

---

---

---

The display will only show statistical values:

- Number of batch (File)
- Name of the material to be measured
- Date and time of the measurement series
- Last reading
- Average
- Max.
- Min.
- Standard deviation (Std dev)
- Number of measured values (Records)

The measuring values can be shown as graph by pressing ►

### Displaying the saved measured values on a PC

The software Tension Inspect 3 is supplied with the tension meter. It allows you to easily and accurately analyze the saved measured values and export them to an Excel table.



### Sample memory printout

#### Deleting the saved measured values

17.10.2018 12:29	ETX-Series-420 100 cN	Unit cN	
Material: PA 0.2 mm	Material: PA 0.2 mm	Material: PA 0.2 mm	
Start: 11:38:09 17.10.18	Start: 11:39:10 17.10.18	Start: 11:40:12 17.10.18	
Stop: 11:38:17 17.10.18	Stop: 11:39:18 17.10.18	Stop: 11:40:20 17.10.18	
Last: 23.7	Last: 22.1	Last: 23.9	
Avg: 23.6	Avg: 23.4	Avg: 23.5	
Max: 24.6	Max: 24.3	Max: 24.5	
Min: 21.6	Min: 21.7	Min: 21.4	
Std dev: 12.5	Std dev: 11.5	Std dev: 12.0	
Peak max: 57.0	Peak max: 54.4	Peak max: 56.4	
Peak min: 4.0	Peak min: 4.4	Peak min: 4.0	
HI-Alarm: 85.0	HI-Alarm: 85.0	HI-Alarm: 85.0	
Lo-Alarm: 15.0	Lo-Alarm: 15.0	Lo-Alarm: 15.0	
Records: 8000	Records: 8000	Records: 8000	
	37.4	22.9	38.5
	41.0	20.6	38.2
	43.8	19.0	39.9
	46.1	18.9	41.0
	47.8	21.5	43.0
	48.9	27.8	45.4
	49.7	35.5	46.6
	49.8	41.5	46.6
	49.2	44.1	46.7

If data is saved in the tension meter, the display shows **Mem** and indicates the free memory space.

#### Deleting data:

1. Press the RECALL ◀ and ▶ buttons.
2. Then press the  button and confirm with the  button. This clears the memory. This clears the memory.

---

---

### 7.3 Memory mode F

Data is recorded during a user-defined period. The tension meter records 2 measured values/sec.

#### Saving data

##### Requirements:

In the main menu, select Memory Settings and then memory mode F.

##### To save the first measurement series

1. Press the **MEMORY** button to start recording the measured values.
2. While recording is in process, **Rec F** flashes in the display.
3. Once the set time has elapsed, no more data will be saved. The display shows **Mem C**, the memory position and the free memory space.
4. If you press the **MEMORY** button before the set time has elapsed, no more data will be saved. The data is saved automatically. The display shows “**Mem F**, the memory position and the free memory space.

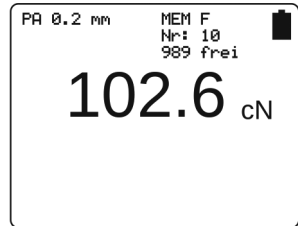

##### To save more measurement series

1. Press the **MEMORY** button to start recording the measured values.
2. While recording is in process, **Rec F** flashes in the display.

**i** To abort data recording, press the **ESC EXT** button. This deletes the procedure. No data will be saved.

##### To save more measurement series:

1. Press **MEMORY** the button to start recording the measured values.
2. While recording is in process, **Rec F** flashes in the display.

##### Displaying the saved measured values

1. Press the **RECALL** ◀ and ▶ buttons simultaneously to display the saved data.
2. The ◀ and ▶ buttons allow you to switch between the various measurement series.

The measuring values can be shown as graph by pressing ▶

The display will only show statistical values:

- Number of batch (File)
- Name of the material to be measured
- Date and time of the measurement series
- Last reading
- Average
- Max.
- Min.
- Standard deviation (Std dev)
- Number of measured values (Records)

The measuring values can be shown as graph by pressing ►

### Displaying the saved measured values on a PC



The Software Tension Inspect 3 is supplied with the tension meter. It allows you to easily and accurately analyze the saved measured values and export them to an Excel table.

17.10.2018 12:29	ETX-Series-420 100 cN	Unit cN	
Material: PA 0.2 mm	Material: PA 0.2 mm	Material: PA 0.2 mm	
Start: 11:38:09 17.10.18	Start: 11:39:10 17.10.18	Start: 11:40:12 17.10.18	
Stop: 11:38:17 17.10.18	Stop: 11:39:18 17.10.18	Stop: 11:40:20 17.10.18	
Last: 23.7	Last: 22.1	Last: 23.9	
Avg: 23.6	Avg: 23.4	Avg: 23.5	
Max: 24.6	Max: 24.3	Max: 24.5	
Min: 21.6	Min: 21.7	Min: 21.4	
Std dev: 12.5	Std dev: 11.5	Std dev: 12.0	
Peak max: 57.0	Peak max: 54.4	Peak max: 56.4	
Peak min: 4.0	Peak min: 4.4	Peak min: 4.0	
HI-Alarm: 85.0	HI-Alarm: 85.0	HI-Alarm: 85.0	
Lo-Alarm: 15.0	Lo-Alarm: 15.0	Lo-Alarm: 15.0	
Records: 8000	Records: 8000	Records: 8000	
	37.4	22.9	38.5
	41.0	20.6	38.2
	43.8	19.0	39.9
	46.1	18.9	41.0
	47.8	21.5	43.0
	48.9	27.8	45.4
	49.7	35.5	46.6
	49.8	41.5	46.6
	49.2	44.1	46.7

### Deleting the saved measured values

If data is saved in the tension meter, the display shows **Mem** and indicates the free memory space.

#### Deleting data:

1. Press the RECALL ◀ and ▶ buttons.
2. Then press the  button and confirm with the  button. This clears the memory. This clears the memory.



---

---

## 7.5 Memory mode H

The last max. 128 values are saved. In graphical mode, the display freezes so that you can view it after completion of the measurement. In numerical mode, the last measured value is displayed.

**NOTE:** This memory mode does not record PEAK values.

### Saving data

#### Requirements:

1. In the main menu, select **Memory Setting** and then memory **mode H**.
2. Set the X-axis as described in section 3.2

#### To save the first measurement series:

1. Press the button to freeze the recording of the measured values.

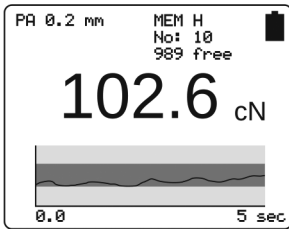

If you have recorded less than 128 measured values, you will continue recording by pressing the **MEMORY** button. If the graphics window is full, its contents will be shifted to the left and you can only freeze the last 128 measured values.

2. To save the graphics and measured values for later evaluation, press the **SET DAMP** button. This returns the tension meter to measuring mode.
3. If you press the **ESC EXIT** or **MEMORY** button, no data will be saved and the tension meter returns to measuring mode.

#### Displaying the saved measured values

1. Press the **RECALL** ◀ and ▶ buttons simultaneously to display the saved data.
2. The ◀ and ▶ buttons allow you to switch between the various measurement series.

---

---

The display will only show statistical values:

- Number of batch (File)
- Name of the material to be measured
- Date and time of the measurement series
- Last reading
- Average
- Max.
- Min.
- Standard deviation (Std dev)
- Number of measured values (Records)

The measuring values can be shown as graph by pressing ►

### Displaying the saved measured values on a PC

The Software Tension Inspect 3 is supplied with the tension meter. It allows you to easily and accurately analyze the saved measured values and export them to an Excel table.

#### Sample memory printout



17.10.2018 12:22	ETX-Series-420 100 cN	Unit cN	
Material: PA 0.2 mm	Material: PA 0.2 mm	Material: PA 0.2 mm	
Start: 12:15:44 17.10.18	Start: 12:16:21 17.10.18	Start: 12:17:20 17.10.18	
Stop: 25 sec.	Stop: 25 sec.	Stop: 25 sec.	
Last: 20.7	Last: 24.6	Last: 27.2	
Avg: 23.1	Avg: 23.5	Avg: 23.4	
Max: 32.1	Max: 31.3	Max: 33.3	
Min: 13.4	Min: 14.0	Min: 13.7	
Std dev: 3.4	Std dev: 3.1	Std dev: 3.9	
Peak max: 0*	Peak max: 0	Peak max: 0	
Peak min: 0*	Peak min: 0	Peak min: 0	
HI-Alarm: 85.0	HI-Alarm: 85.0	HI-Alarm: 85.0	
Lo-Alarm: 15.0	Lo-Alarm: 15.0	Lo-Alarm: 15.0	
Records: 128	Records: 128	Records: 128	
	21.1	19.5	18.4
	24.6	27.8	28.5
	23.1	18.6	20.0
	21.9	27.9	28.4
	26.6	22.3	20.2
	18.6	26.0	28.5
	29.3	22.3	20.1
	18.2	27.8	30.7
	20.8	18.9	17.8

\*PEAK are not recorded; therefore 0 in the printout

### Deleting the saved measured values

If data is saved in the tension meter, the display shows **Mem** and indicates the free memory space.

#### Deleting data:

1. Press the RECALL ◀ and ▶ buttons.
2. Then press the  button and confirm with the  button. This clears the memory. This clears the memory.

---

---

## 7.6 Memory mode D

Recording single readings by the operator instigation.

### Saving data

#### Requirements:

1. In the main menu, select **Memory Settings** and then memory mode **D**.

#### Saving:

1. By pressing the  button the current reading will be saved.

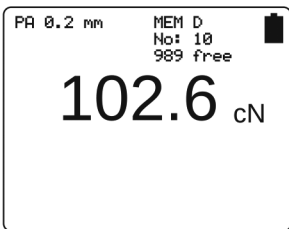

### Displaying the saved measured values

- 1 Press the RECALL ◀ and ▶ buttons simultaneously to display the saved data.

The display will only show statistical values:

- Number of batch (File)
- Name of the material to be measured
- Date and time of the measurement series
- Last reading
- Average
- Max.
- Min.
- Standard deviation (Std dev)
- Number of measured values (Records)

### Displaying the saved measured values on a PC

The software Tension Inspect 3 is supplied with the tension meter. It allows you to easily and accurately analyze the saved measured values and export them to an Excel table.

---

---

## Sample printout

17.10.2018 11:37

ETX-Series-420 100 cN



Unit : cN

Material: PA 0.2 mm
Start: 11:32:30 17.10.18
Stop: 11:32:38 17.10.18
Last: 23.3
Avg: 23.6
Max: 24.4
Min: 21.9
Std dev: 0.6
Peak max: 53.5
Peak min: 4.5
HI-Alarm: 85.0
Lo-Alarm: 15.0
Records: 16

## Deleting the saved measured values

If data is saved in the tension meter, the display shows **Mem** and indicates the free memory space.

### Deleting data:

1. Press the RECALL ◀ and ▶ buttons.
2. Then press the  button and confirm with the  button. This clears the memory. This clears the memory.

---

---

---

## 8.0 PC COMMUNICATIONS (USB INTERFACE)

You can store and display the statistics of one measuring series (last measured value, the average, the minimum and maximum measured values, the peaks, the standard deviation)

### 8.1 Installing the USB Driver

For data transfer to the PC, you will need a USB driver. If no matching driver is installed on your PC, the Windows Found New Hardware Wizard appears when you connect the unit to the computer for the first time. Follow the wizard steps. Specify the location of the driver on the supplied CD-ROM. You will find the driver in the "Driver" folder

### 8.2 The TENSION INSPECT 3 program

The Tension Inspect 3 software is described in a separate user manual

### 8.3 Terminal program

The contents of the memory can be transferred to a PC using the USB interface of the tension meter.

1. Connect the ETX/ETPX to the computer using the USB cable type EK0662 which is supplied with the tension meter.

#### **Prerequisites:**

A communication program, such as Terminal, must be installed and configured on the computer.

PC communication commands (polling)

Requesting data: (data is requested by PC polling)

- The ASCII character **r** is used to transfer the contents of the memory to the PC.

---

---

---

## 9.0 SERVICE AND MAINTENANCE

The tension meter is easy to maintain. Depending on operating time and load, the instrument should be checked according to the locally valid regulations and conditions (as described in Chapter 3.6.3). The use of other test methods than the procedure described in Chapter 3.6.3 may cause deviating measuring results.

### 9.1 Rollers

To order spare rollers:

Model: ETB-100 (given on rear side of tension meter)

Serial number: 420 - 88888 (given on rear side of tension meter)

Standard rollers:

Model number: R542017

Delivery: 1 set (3 pcs.) of spare rollers 2000 m/min

To order ceramic pins:

Model: ETPB-100 (given on rear side of tension meter)

Serial number: 420-88888 (given on rear side of tension meter)

Ceramic pins:

Model number: R542020

Delivery: 1 set (3 pcs.) of spare ceramic pins 6000 m/min

### 9.2 Replacing the rollers/ceramic pins

**NOTE:** Replacing rollers by ceramic pins or ceramic pins by rollers can only be performed at the manufacturer's facility.

**Required tools:** Screwdriver with 1.5 mm blade width open end wrench with 4 mm jaw width.

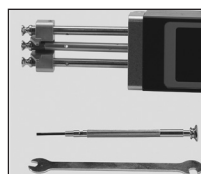

#### To remove the filament guide

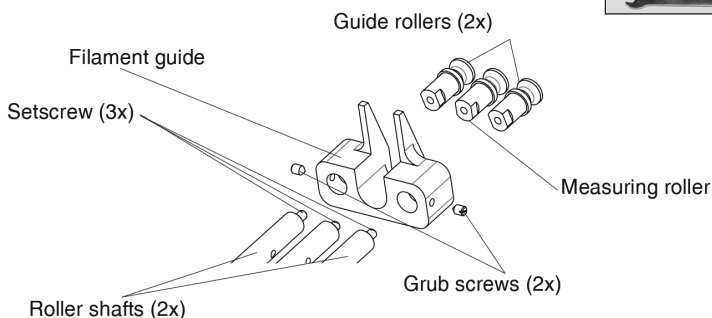

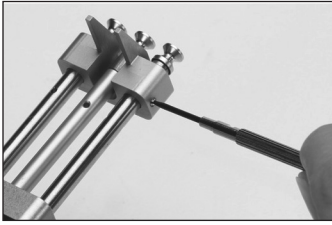

Step 1. Loosen the grub screws with the supplied screwdriver (1.5 mm blade width).

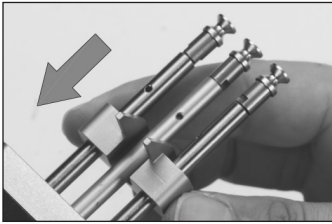

Step 2. Slide the filament guide down the Roller shafts in the direction of the arrow.

### To remove the used rollers

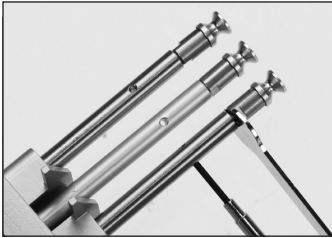

Step 1 Loosen the rollers with the supplied open end wrench (4 mm jaw width).

**NOTE:** Should any of the three threaded studs be damaged, replace it by one of the threaded studs supplied with the new rollers.



Step 2 Screw off the rollers

**NOTE:** When loosening the rollers, steady the roller bolts with the supplied screwdriver to prevent loosening of the roller shafts.

### To mount new rollers

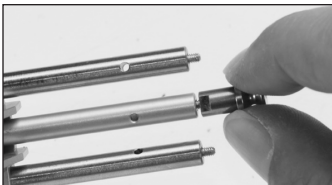

Step 3 Screw the new rollers to the roller shafts.

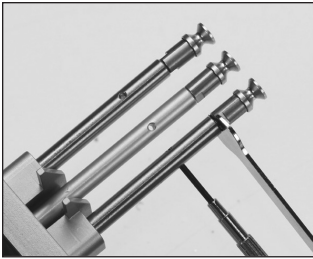

Step 4 Carefully tighten the new guide and measuring rollers with the supplied open end wrench (4 mm jaw width) until hand-tight.

**NOTE:** When tighten the rollers, steady the roller bolts with the supplied screwdriver to prevent the roller shafts from being twisted off.

### To mount the filament guide

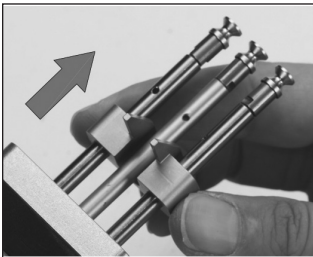

Step 1 Slide the filament guide up the Roller shafts in the direction of the arrow.

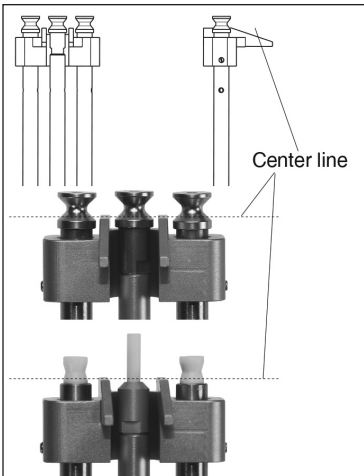

Step 2 Push the filament guide upward far enough to ensure that the rollers do not rub against the filament guide and that the process material can slide unhindered into the roller grooves (center line).

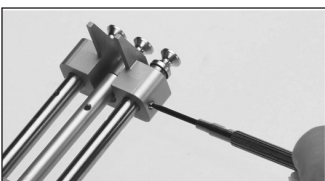

Step 3 Tighten the grub screws with the supplied screwdriver (1.5 mm blade width).



## 10.0 SPECIFICATIONS

Calibration	According to factory procedure
Units of Measure	cN, g, N, lb, user selectable
Accuracy	$\pm 1\% \text{ FS}^* \pm 1 \text{ digit}$ (typical $\pm 0.5\% \text{ FS}^*$ )
Resolution	0.1 cN
Overrange	10% FS*, without accuracy guarantee
Overload protection	200% FS*
Measuring principle	Strain gauge bridge
Meas. roller deflection	0.5 mm, max
Signal processing	Digital
Damping	moving electronic (averaging)
Sampling rate (internal)	Approx. 1 KHz
Sampling rate	200 Hz, 2 Hz: AVG, MIN and MAX
Display update rate	2 times per second
Display	Color TFT 128 x 160
Memory	Average, last value, MAX, MIN
Communication frequency	max. 200 readings/sec
Temperature coefficient	Gain: less than $\pm 0.01\% \text{ FS}^*/^\circ\text{C}$
Temperature range	10 – 45° C
Air humidity	85% RH, max.
Auto Power Off	After approx. 3 min. of non-use
Power supply	LiPo accumulator (20 h continuous use, 3 ½ hour charging time), USB AC adapter 100 ... 240 V AC with 4 adapters (EU/USA/UK/AUS-NZ)
Housing material	Aluminium
Housing dimensions	182 mm x 54 mm x 41 mm (L x W x H)
Weight (net /gross)	Approx. 310 g / 1220 g
*FS = Full Scale	

## Available Models

**NOTE:** The standard series is also available with the following modifications (customized versions): - Special calibration using customer supplied material.

Model	Tension Ranges (cN)	Measuring Head Width (mm)	Factory calibration with running filament
ETX-100	0.3 – 100.0	24	PA: 0.20 mm Ø
ETX-200	2.0 – 200.0	24	PA: 0.20 mm Ø
ETX-500	2.0 – 500.0	24	PA: 0.20 mm Ø
ETPx-100	0.3 – 100.0	22	PA: 0.20 mm Ø
ETPx-200	2.0 – 200.0	22	PA: 0.20 mm Ø
ETPx-500	2.0 – 500.0	22	PA: 0.20 mm Ø

\* Outer distance between outside guide rollers / pins

\*\* Suitable for 95% of all applications. PA = Polyamide Monofilament. If the material to be measured differs significant from the factory calibration material in diameter, rigidity, shape, etc., we recommend calibration using customer supplied material. For this purpose a material sample of about 5m should be supplied. International unit of tensile force:

1 cN = 1.02 g = 0.01

ETB: Calibration with approx. 100 m/min

ETPB: Calibration with approx. 60 m/min

### ETX Guide Rollers

V-Groove	Line Speed m/min ... max.	Roller Material
Standard	2000	Hardcoated aluminum

### ETPX Guide Pins

V-Groove	Line Speed m/min ... max.	Roller Material
Standard	6000	Oxide ceramic

---

---

---

## 11.0 WARRANTY

ELECTROMATIC Equipment Co., Inc. (ELECTROMATIC) warrants to the original purchaser that this product is of merchantable quality and confirms in kind and quality with the descriptions and specifications thereof. Product failure or malfunction arising out of any defect in workmanship or material in the product existing at the time of delivery thereof which manifests itself within one year from the sale of such product, shall be remedied by repair or replacement of such product, at ELECTROMATIC's option, except where unauthorized repair, disassembly, tampering, abuse or misapplication has taken place, as determined by ELECTROMATIC. All returns for warranty or non-warranty repairs and/or replacement must be authorized by ELECTROMATIC, in advance, with all repacking and shipping expenses to the address below to be borne by the purchaser.

THE FOREGOING WARRANTY IS IN LIEU OF ALL OTHER WARRANTIES, EXPRESSED OR IMPLIED, INCLUDING BUT NOT LIMITED TO, THE WARRANTY OF MERCHANTABILITY AND FITNESS FOR ANY PARTICULAR PURPOSE OR APPLICATION. ELECTROMATIC SHALL NOT BE RESPONSIBLE NOR LIABLE FOR ANY CONSEQUENTIAL DAMAGE, OF ANY KIND OR NATURE, RESULTING FROM THE USE OF SUPPLIED EQUIPMENT, WHETHER SUCH DAMAGE OCCURS OR IS DISCOVERED BEFORE, UPON OR AFTER REPLACEMENT OR REPAIR, AND WHETHER OR NOT SUCH DAMAGE IS CAUSED BY MANUFACTURER'S OR SUPPLIER'S NEGLIGENCE WITHIN ONE YEAR FROM INVOICE DATE.

Some State jurisdictions or States do not allow the exclusion or limitation of incidental or consequential damages, so the above limitation may not apply to you. The duration of any implied warranty, including, without limitation, fitness for any particular purpose and merchantability with respect to this product, is limited to the duration of the foregoing warranty. Some states do not allow limitations on how long an implied warranty lasts but, notwithstanding, this warranty, in the absence of such limitations, shall extend for one year from the date of invoice.

ELECTROMATIC Equipment Co., Inc.  
600 Oakland Ave. Cedarhurst, NY 11516—USA  
Tel: 1-800-645-4330/ Tel: 516-295-4300/ Fax: 516-295-4399

Every precaution has been taken in the preparation of this manual. Electromatic Equipment Co., Inc., assumes no responsibility for errors or omissions. Neither is any liability assumed for damages resulting from the use of information contained herein. Any brand or product names mentioned herein are used for identification purposes only, and are trademarks or registered trademarks of their respective holders

---

---

---

**NOTES**

**CHECKLINE®**  
MADE TO MEASURE

Checkline • 600 Oakland Ave, Cedahurst NY 11516 - USA  
[www.Checkline.com](http://www.Checkline.com) • [info@checkline.com](mailto:info@checkline.com) • 516-295-4300