

Western's Dial Indicators have the special Push to Read feature, which allows the operator to Scan through a Pit to obtain an idea of the shape. By placing the index finger on the Plunger, the operator can put a slight amount of pressure onto the Contact Point. The operator then pulls the Pit Gauge Blade through the Pit, paying careful attention that the contact point does not catch on the irregular surface. This allows the operator to watch the depth indications, so he will see both his depth and length displacement.

### Scanning

Magnetic Hold Downs need to be adjusted to fit the surface being tested. If the surface is flat or convex, the Hold Downs can be adjusted, with the Allen Key, to be flush with the knife edge of the blade. However, if the surface is curved (concave), like the inside of a vessel, the Hold Downs need to be adjusted so they don't interfere with the contact of the knife edge on the work piece.

### Magnetic Hold Downs

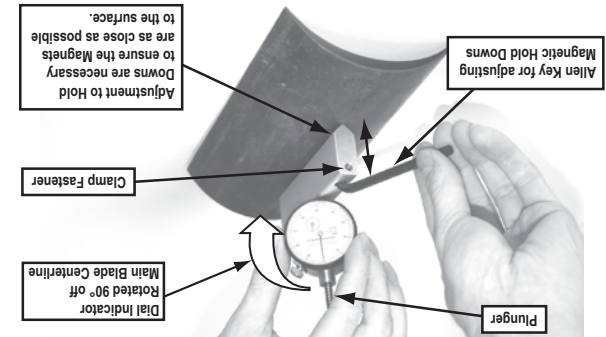

Dial Zeroed. The position (or rotation) of the Dial Indicator can be changed by simply loosening the Clamp Fasteners or Set Screw, and rotating the Dial Indicator around the Blade. After the Dial Indicator is rotated, the unit should also be Dial Zeroed.

### Indicator Positioning

To select Metric or Imperial Measurement, simply press the m/in Button. When not in use, press the On/Off Button to turn the indicator off. Digital indicators do not shut off automatically.

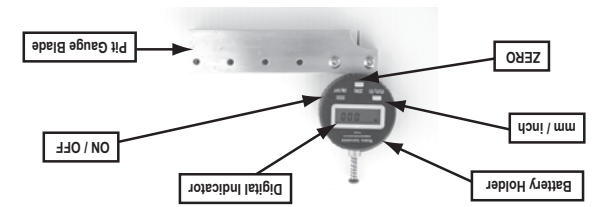

Digital Indicators can be Height Zeroed or Positioned in the same way as Mechanical Dial Indicators. To Zero the Digital Indicator simply press the Zero Button when the Contact Point is on a reference surface. If the Digital Indicator is Height Zeroed, press Zero when the Plunger is fully retracted.

### Zeroing a Digital Indicator

Assuring compliance with Corrosion Allowances for equipment wherever Corrosion affects materials, such as Pipeline, Vessels, Piping, Storage Tanks, Oil Country Tubular Goods, Drill Pipe, Bottom Hole Assemblies, Bridges and Structures, Shipping, Concrete, and Aircraft Components. Due to their versatility, many of our Pit Gauges have other uses, such as wear measurement, Weld Alignment, Structural Fit-up, etc.

Western Instruments Dial Pit Gauges allow the Corrosion Inspector to conveniently measure Pit Depth or material loss in areas of Weight-Loss Corrosion. Various types are available for different applications, including the Tri-Gauge® for basic evaluation and the Bridging Pit Gauge for evaluating large areas of weight loss corrosion. The right gauge for the right application.

Model	Part #	Description
Tri-Gauge	N88L-1	Lever Type Pit Gauge for Evaluation of Corrosion
Basic	N88-2	Centre mount 2.5" (64mm) Blade, our most popular Gauge
Basic Plus	N88-3	Centre mount 3.5" (89mm) Blade
Basic Plus Magnetic	N88-3M	Centre mount c/w Two(2) magnet cartridges. 3.5" (89mm) Blade
Pocket	N88-4	Dual Edge Blade (reversible). 1.5" (38mm) long and spot base
Reaching	N88-5	4.75" (121mm) Blade. End Mount Dial Indicator with Nose Cutout.
Reaching Magnetic	N88-5M	4.75" (121mm) Blade c/w Two(2) magnet cartridges.
Reaching Plus	N88-6	6" (152mm) Blade. End Mount Dial Indicator with Nose Cutout.
Reaching Plus Magnetic	N88-6M	6" (152mm) Blade c/w Two(2) magnet cartridges.
Reference Gauge	N88-12	5.5" (140mm) long, 0.75" (19mm) wide with inverted V Edge, 2 magnet cartridges. Similar and interchangeable with Bridging Pit Gauge Main Blade.

NOTE: All Blades are 0.500" (13mm) Wide with a Knife Edge, except the Reference Gauge

### Dial & Digital Indicators



<b>Metric Dial Indicator</b>	Range: 0.0-10mm Resolution: 0.01mm Dial φ: 35.5mm
<b>Imperial Dial Indicator</b>	Range: 0.0-0.5inches Resolution: 0.001inches Dial φ: 1.4inches
<b>Digital Indicator</b>	Range: 0.0-0.5inches, 0.0-10mm

### Contact Points

Western offers a variety of Contact Points, which are all 0.625" (16mm) long. Any ADG Contact point can be used with our special dial indicators, but a different length may affect Height Zeroing, or the vertical position of the Dial Indicator. Contact Points are easily replaced, by extending the Contact Point, and turning it counter clockwise.

<b>1-Standard Tip</b>	0.040" Dia.	#1 Contact Point - Standard N88-S
<b>2-Conical Tip</b>	0.010" Dia.	#2 Contact Point - Conical, N88-C
<b>3-Needle Tip</b>	0.005" Dia.	#3 Contact Point - Needle N88-N



Height Zeroing should be done whenever the unit is put into use. Be sure that the Contact Point does not lift the blade off the surface.

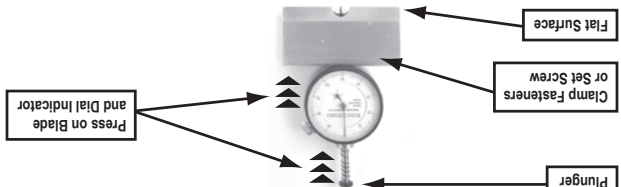

Loosen the Fastener(s) holding the Dial Indicator in place. Hold the Blade firmly on a Flat Surface, and gently press the body of the Dial Indicator down until the contact point touches the flat surface. Carefully re-tighten the Clamp Fastener(s) or the Set Screw. Any fine zeroing can be done by rotating the Bezel Scale on the Dial Indicator.

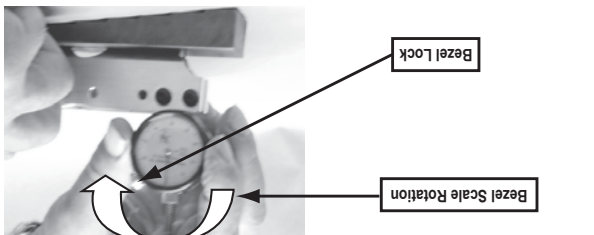

To quickly check the Zero Point of the Dial Indicator, place the Blade on a relatively smooth surface. Gently press the Plunger, until the contact point touches the surface. While the contact point is on the surface, loosen the Bezel Lock, and rotate the Bezel Scale until it reads '0' with respect to the pointer. Be mindful that the blade is 'normal' to the surface.

### Scale Zeroing

The vertical position of the Contact Point, needs to be Zeroed with respect to the Knife Edge of the Blade. Zeroing can be accomplished in two ways: by adjusting the Height of the Dial Indicator in the Blade; or by Rotating the outer Bezel Scale while pressing on the Plunger onto a flat surface.

### Zeroing Dial Indicator

The Reversible Blade of the Pocket Pit Gauge (N88-4) is used to measure isolated pitting with its two long Knife Edge Blade, as well as a Spot Blade with two Reference Points that are 0.375" (9.5mm) apart. The Spot Blade is used on Compound Curvatures such as the Knuckle of a Vessel Head, Pumps (Body/Impeller), Valves (Body/Ball), Propellers, Turbine Blades, Gas Cylinders, etc.

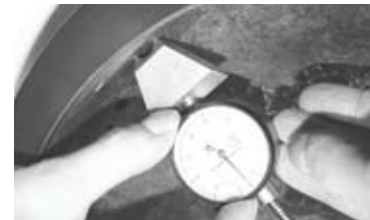

### Pocket Pit Gauge

Western's patented Lever Type Pit Gauge with Metric and Imperial Scales. Inquire at your supplier for information, or visit: [www.westerninstruments.com](http://www.westerninstruments.com)

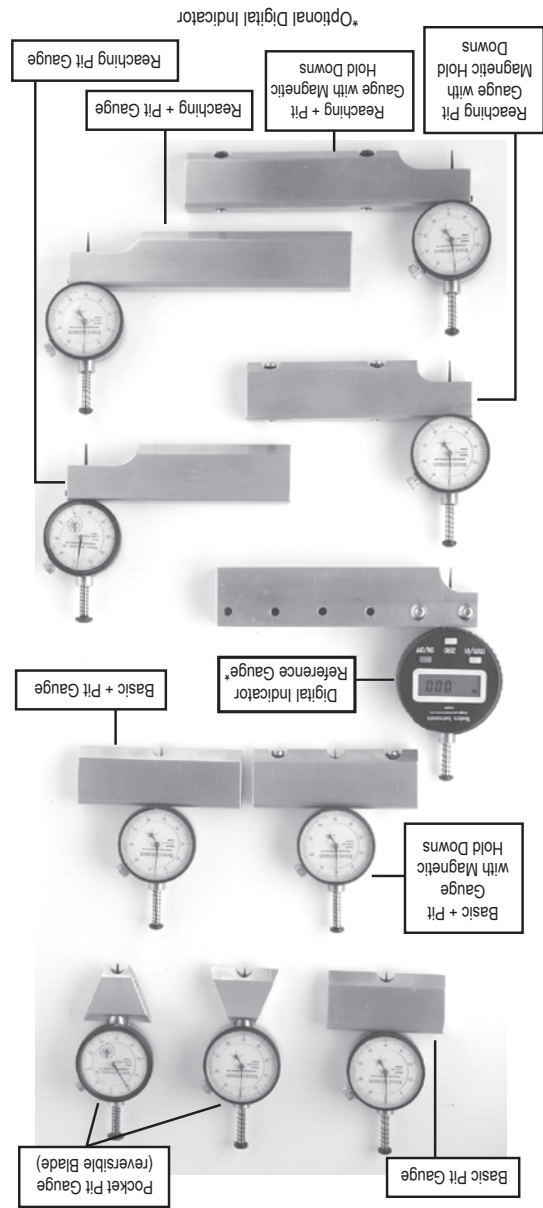

### Dial Indicator Pit Gauges

#### Warranty

Western Instruments warrants its products, against defects in materials and workmanship for a period of 1 year from receipt by the end user. If Western Instruments receives notice of such defects during the warranty period, Western Instruments will either, at its option, repair, replace, or condemn products that prove to be defective. Consumable items, such as Contact Points, Batteries, and the like are warranted for 30 days, from receipt by the end user.

Any warranty is void if the unit has been modified in any way, or if it has been repaired by an unauthorized agency. The end user agrees that any equipment's disposition, when returned for warranty work, is at the full discretion of Western Instruments as to whether a claim is under warranty, or due to misuse. Western Instruments warranty shall overlook normal wear, however does not include operation outside the environmental specification of the product. All warranty work is FOB Western Instruments, and any returned units shall include a written description, by the end user, of the fault.

Western Instruments makes no other warranty, either expressed or implied, with respect to this product. Western Instruments specifically disclaims any liability arising from the use of this equipment. For the correct use of the product, refer to the Operating Instructions, furthermore we recommend instructional training to NACE, or other regulatory authority qualifications. Western Instruments highly recommends the end user exercise all possible safety precautions, including use of protective equipment, while operating this or other industrial equipment.

# Western Instruments

Est. 1965

Ph: (780) 459 6720  
Fax: (780) 459 7837

e-mail: [info@westerninstruments.com](mailto:info@westerninstruments.com)  
web: [www.westerninstruments.com](http://www.westerninstruments.com)

Box 72, Site 2, R.R.#1  
St. Albert, AB  
T8N 1M8

Distributed by

[www.westerninstruments.com](http://www.westerninstruments.com)



Assuring compliance with Specifications for Corrosion & Erosion Depth Measurement.



**Pit Gauge**  
Product Series

Western Instruments  
Est. 1965



## Bridge Type Pit Gauges

Western's advanced *Bridging Pit Gauge System*® and our new *Jr. Bridging Pit Gauge*® take over, where the capabilities of our standard Pit Gauges fall short, for evaluating large areas of Weightloss Corrosion. These *Bridging Bar* type Pit Gauges can also be used to measure Dents and Buckles on Pipelines, Shell Settlement on Storage Tanks, etc. These various forms of *Bridging Bars* can utilize any of our exclusive Dial Indicators (Imperial, Metric, or Digital), with any of our Custom Engineered Contact Points.

There are several important features to a *Segmented Bridge*, where various elements (Blades and Tee's) are assembled to form a *Bridging Bar*. Firstly, they can be assembled to follow the contour of a slightly irregular surface. This contouring feature is important for Pipeline, Storage Tank, and Pressure Vessel inspections, where 'hills and valleys' always exist. Secondly, the models listed below are of a given length, however extra elements can be added to increase their over all length. As illustrated, these units can be assembled in Spanning or Cantilevering configurations, and finally, the Main Blade can be used individually for isolated or cone type Pitting.

## Jr. Bridging Pit Gauge® Group

The *Jr. Bridging Pit Gauge*® Group provides Inspectors with an Economical Alternative to the *Bridging Pit Gauge System*®. The new *Jr. Bridging Pit Gauge*® is available as 3 models; the standard *Jr. Bridging Pit Gauge*®, the *Plus*, and the *Super*. The standard *Jr. Bridging Pit Gauge*® assembles to an overall length of 13½" (340mm). The *Jr. Bridging Pit Gauge Plus*® can be assembled in either Spanning or Cantilevering Configurations up to 15 ½" (394mm) long. While the *Jr. Bridging Pit Gauge Super*® can also be assembled in both Spanning or Cantilevering Configurations, up to 27" (685mm) long.

The *Junior's* Main Blade, and the optional Extender Blades are fitted with strong magnets that secure any of the *Jr. Bridging Pit Gauges*® to the surface of the workpiece. These Magnetic Hold Downs have several benefits, such as; Aligning the unit to Concave or Convex surfaces, keeping the operator free to record readings or manipulate the assembly when Scanning through Pits and Weight loss Corrosion. These features position the *Plus*, and the *Super* far ahead of any competitive units.

Name	Part #	Description
Jr. Bridging Pit Gauge®	N88-11	Main Blade, Imperial Dial Indicator, 2-Extender Tees, 2-End Blades, Hardware, Extra Contact Point, and Carrying Case.
Jr. Bridging Pit Gauge Plus®	N88-11P	Main Blade, Imperial Dial Indicator, Connector Blade, 2-Extender Tees, 2-End Blades, Hardware, Extra Contact Point, and Carrying Case.
Jr. Bridging Pit Gauge Super®	N88-11S	Main Blade, Imperial Dial Indicator, 3-Connector Blades, 4-Extender Tees, 2-End Blades, Hardware, Extra Contact Point, and Carrying Case.
Main Blade	N88-11-1	Center and End Dial Indicator Mounting Positions, Fitted Permanent Magnets. Cutaway Nose for next to welds. 5.5" (144mm) long.
Connector Blade	N88-11-2	Joins Tee Sections to increase length. Fitted Permanent Magnet. 3.5" (90mm) long.
End Blade	N88-11-3	Mounts on end of Tee for extra contact. 1.5" (38mm) long. Doubles as Slider Blade for <i>Plus</i> ® and <i>Super</i> ® models.
Extender Tee	N88-11-5	Extends effective length of all models. 5.5" (140mm) long (Longer Tees are optional).
Fastener Kit	N88-11-7	Fasteners, Allen Key, Nylon Thumb Screws, Contact Point.
Carrying Case	N88-11-8	Hard Sided Plastic Carrying Case for entire kit.

## Assembly

All Bridge type Blades (Main, Extender, End, & Slider) have two distinct sides, that are differentiated by the transverse mounting holes. On one side there is a clearance hole, while on the opposite side the hole is threaded (#10-24 UNC). When assembling, start the fasteners on the Thread Clearance Side of the Blades, so the fasteners can be properly tightened against the Extender Tee's. Do not tighten fasteners if an Extender Tee is not within the Slot area of a Blade.

When assembling the unit, press firmly (as illustrated) on the Extender T, and the Blade you are attaching it to, while tightening the 10-24x½" Button Head Machine Screws with the 1/8" Allen Key. When assembled in this fashion, the overall length of the unit should have a straightness of approximately +/-0.015". When more accuracy is required, assemble the unit on a flat surface.

If the surface of the workpiece has an irregular surface (slight curve, distinct bend or hills and valleys), simply assemble the Bridging Bar, but do not tighten the fasteners. This will leave the Bridge loose and free to match the contour of the workpiece. When the operator has contoured the assembled Bridge, all the fasteners can be tightened. The operator should be mindful that this contouring assembly will be fine at a given point, however it will need to be checked when the Bridging Bar is repositioned.

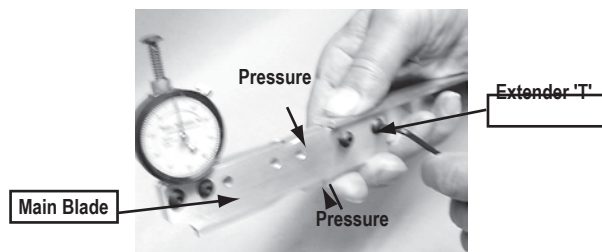

## Magnetic Hold Downs

Magnetic Hold Downs are intended for Scanning with a Bridging Pit Gauge®, however they can be used on any of the *Jr. Bridging Pit Gauge*® Group, with a diminished range of motion. Magnetic Hold Downs also provide the inspector with increased mobility, as he is not required to support the Bridging Pit Gauge. The following are instructions for the use, and using, the Magnetic Hold Down Blocks.

Magnetic Hold Down Blocks are designed to easily slide on the Extender Tee's, and are best put in place prior to assembly. With the Bridge assembled, and placed on the workpiece, the entire Bridging Pit Gauge® can travel over a distance of about 9" (290mm). Longitudinal or position measurements of the Bridging Pit Gauge® are taken off the Scales (imperial and metric divisions) that are fastened to the top of the Extender Tees.

## Cantilevering Assembly

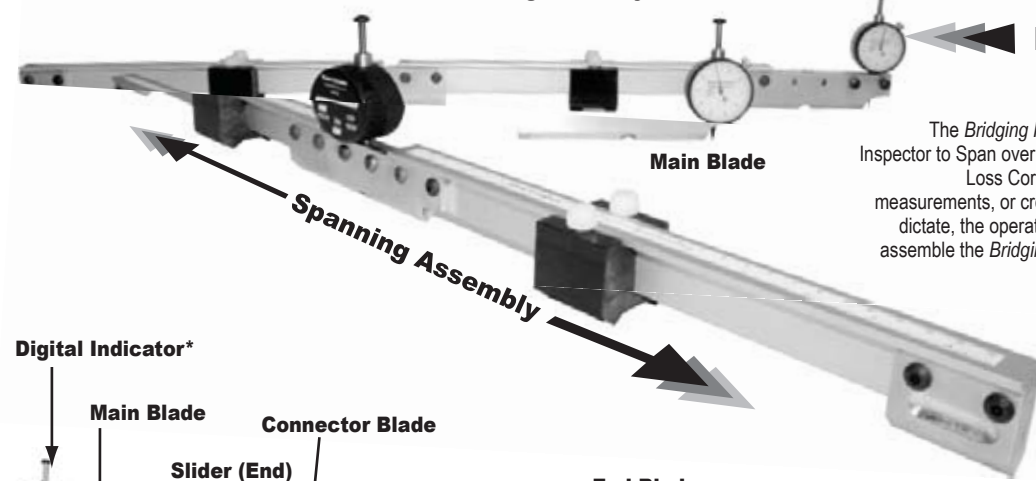

## Bridging Pit Gauge® System

The *Bridging Pit Gauge*® System allows the Corrosion Inspector to Span over or Cantilever into Large Areas of Weight Loss Corrosion, to obtain accurate and consistent measurements, or cross sections, of Pit Depth. As conditions dictate, the operator can simply use the Main Blade or can assemble the *Bridging Pit Gauge*® up to an over all length of 28½" (725mm).

The contact Surfaces (Blades) of the *Bridging Pit Gauge*® are fitted with an exclusive Knife Edge, so they can be used on Flat, ID (Convex), and OD (Concave) Surfaces, where a flat or notched contact surface can introduce error on Convex Surfaces. Like our Standard Pit Gauges, the Knife Edge gives the operator a clear view of the contact point, and the area being inspected.

With the addition of the optional Magnetic Hold Downs, the operator uses their width to quickly align the *Bridging Pit Gauge System*® to a curved surface. This leaves his hands free to scan through very large areas of weight loss corrosion. This holds true when the Bridge Elements have been assembled with a slight contour on an irregular surface.

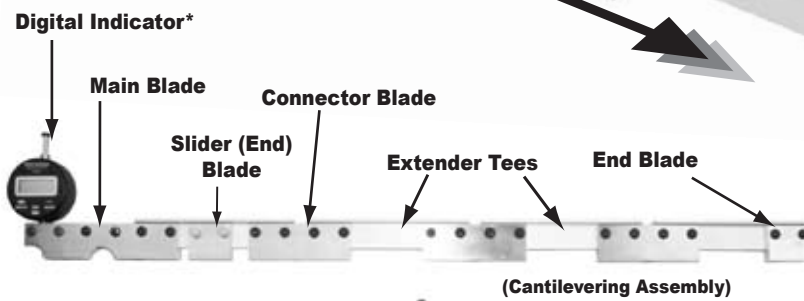

Junior Bridging Pit Gauge Super® (Cantilevering Assembly)



Junior Bridging Pit Gauge Plus® (Cantilevering Assembly)

## Junior Bridging Pit Gauge® & Plus® (Spanning Assembly)\*

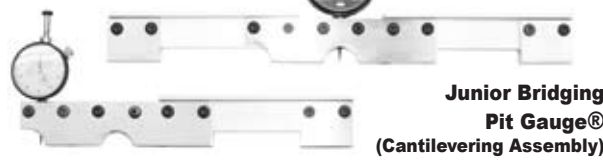

\*Digital Indicator Optional for Bridging Pit Gauges.



Each Magnetic Hold Down is equipped with 2 (two) 1/4"-20 UNC Nylon Thumb Screws. The Thumb Screws have two purposes, firstly to retain or capture the Magnetic Hold Down onto the Extender Tee. The second use of the Nylon Thumb Screws is to set the tension or to lock the Magnetic Hold Downs. As an example, if the Bridging Pit Gauge® is being used vertically, the operator will want the tension set higher, to keep the unit from sliding. If the Bridging Pit Gauge® is being used on a highly irregular surface, the operator will want the Nylon Thumb Screws set very loose, to allow the Blades to more easily slide over the workpiece.

When setting a Bridge to a Convex surface, such as the OD of a Pipe, or a Concave surface, such as the ID of a Vessel, the Magnetic Hold Downs are used to align the entire assembly. The operator will see this when he attempts to rock the Magnetic Hold Downs from Side to Side. If the unit rocks, the Magnetic Hold Downs are not on the same Longitudinal Axis and must be realigned. When the rocking stops, the operator knows the Bridge is aligned, however, most formed surfaces (pipe, vessels, and tanks) are irregular, so rocking may not be eliminated but must be kept to a minimum to increase measurement accuracy.

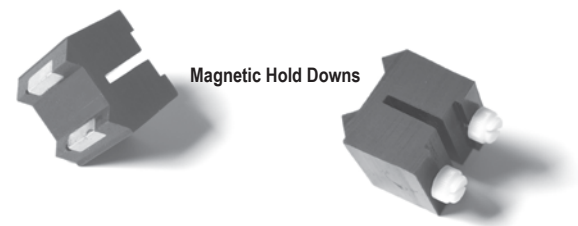

the correct longitudinal position along the Extender Tee. When general evaluation is being done, and the operator is not recording measurements, place the Magnetic Hold Downs in the Middle of the Tee, to allow movement of the Bridge in both directions. When the operator is going to record measurements, for Plotting a Cross-Section, place the Magnetic Hold Downs at the end position of the scan, then move the bridge to the starting position. The operator takes a reference reading, between a magnetic Hold Down and the Scale on the Tee, before starting the longitudinal movement.

## Scanning

Firstly, after a Bridge is assembled, adjusted for the surface contour, and the Magnetic Hold Downs aligned to the surface, the Dial Indicator must be Zeroed (Height or Scale). This will ensure accurate and reproducible measurements. Every time the Bridge is moved to a new location, these parameters (Contour, Alignment, and Hold Down position) must be rechecked and the Dial Indicator re-Zeroed.

With the Bridge Type Pit Gauge fully assembled and placed on the workpiece, Pit Depths and Longitudinal travel can be made. This travel

Name	Part #	Description
Bridging Pit Gauge®	N88-9	Main Blade, Imperial Dial Indicator, Connector Blade, 2-Extender Tees, End Blade, Slider Blade, Hardware, Extra Contact Point, and Carrying Case.
Main Blade	N88-9-1	Center and End Dial Indicator Mounting Positions, Cutaway Nose for next to welds. 5.5" (144mm) long.
Connector Blade	N88-9-2	Joins Tee Sections to increase length. 3.5" (90mm) long.
End Blade	N88-9-3	Mounts on end of Tee for extra contact. 1.5" (38mm) long.
Slider Blade	N88-9-4	Extra Point of Contact and doubles as an End Blade in Spanning Configuration. 1.5" (38mm) long.
Extender Tee	N88-9-5	Extends effective length of all models. 12" (305mm) long (Longer Tees are optional).
Magnetic Hold Downs	N88-9-6	1 required for each Tee Section used. 1½" (41mm) long.
Fastener Kit	N88-9-7	Fasteners, Allen Key, Nylon Thumb Screws, Contact Point.
Carrying Case	N88-9-8	Hard Sided Plastic Carrying Case for entire kit.

permits the Dial Indicator's Contact Point to be moved along the work piece incrementally, to take multiple Pit Measurements. Longitudinal or position measurements are taken off the Scales that are fastened to the Extender Tees. The measurements (depth and length) can then be plotted to obtain a Cross-Sectional View of the corrosion profile.

Scanning through a Pit is covered earlier in this guide, but merits repeating. Western's Dial Indicators have the special Push to Read feature, which allows the operator to Scan through a Pit to obtain an idea of the shape. By placing the index finger on the Plunger, the operator can put a slight amount of pressure onto the Contact Point. The operator then pulls the Pit Gauge Blade through the Pit, paying careful attention that the contact point does not catch on the surface. This allows the operator to watch the depth indications, so he will see both depth and length displacement.

Operators should remember basic survey principles when plotting cross sections. Furthermore, if radial movements are made in increments, and recorded, an entire area of corrosion (lake type) can be mapped.

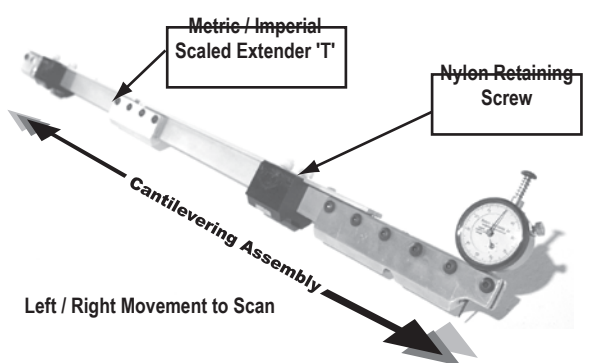

Left / Right Movement to Scan

## Care and Maintenance

Western's ADG Group 1 Dial Indicators (Imperial or Metric), as well as the Digital Indicator were developed for Field Pit Depth Measurement. While ruggedly manufactured, these units should not be dropped or subject to strong Vibration or Impact. While manufactured from Corrosion Resistant Materials, Pit Gauges and their Dial Indicators should be kept clean and dry. Fit and Finish of Bridge Type Pit Gauges, as well as Standard Pit Gauge parts are very important. Operators should not hesitate to file rough edges, or clean with steel wool or 600 Grit wet/dry abrasive cloth. New parts tend to be tightly fit, and will loosen with use. Care must be taken to ensure fasteners are not cross-threaded.