

---

---

## 14.0 WARRANTY

The manufacturer warrants to the original purchaser that this product is of merchantable quality and conforms in kind and quality with the descriptions and specifications thereof. Product failure or malfunction arising out of any defect in workmanship or material in the product existing at the time of delivery thereof which manifests itself within one year from the sale of such product, shall be remedied by repair or replacement of such product, at the manufacturer's option, except where unauthorized repair, disassembly, tampering, abuse or misapplication has taken place, as determined by the manufacturer. All returns for warranty or non-warranty repairs and/or replacement must be authorized by the manufacturer, in advance, with all repacking and shipping expenses to the address below to be borne by the purchaser.

THE FOREGOING WARRANTY IS IN LIEU OF ALL OTHER WARRANTIES, EXPRESSED OR IMPLIED, INCLUDING BUT NOT LIMITED TO, THE WARRANTY OF MERCHANTABILITY AND FITNESS FOR ANY PARTICULAR PURPOSE OR APPLICATION. ELECTROMATIC SHALL NOT BE RESPONSIBLE NOR LIABLE FOR ANY CONSEQUENTIAL DAMAGE, OF ANY KIND OR NATURE, RESULTING FROM THE USE OF SUPPLIED EQUIPMENT, WHETHER SUCH DAMAGE OCCURS OR IS DISCOVERED BEFORE, UPON OR AFTER REPLACEMENT OR REPAIR, AND WHETHER OR NOT SUCH DAMAGE IS CAUSED BY MANUFACTURER'S OR SUPPLIER'S NEGLIGENCE WITHIN ONE YEAR FROM INVOICE DATE.

Some State jurisdictions or States do not allow the exclusion or limitation of incidental or consequential damages, so the above limitation may not apply to you. The duration of any implied warranty, including, without limitation, fitness for any particular purpose and merchantability with respect to this product, is limited to the duration of the foregoing warranty. Some states do not allow limitations on how long an implied warranty lasts but, notwithstanding, this warranty, in the absence of such limitations, shall extend for one year from the date of invoice.

Every precaution has been taken in the preparation of this manual. The manufacturer assumes no responsibility for errors or omissions. Neither is any liability assumed for damages resulting from the use of information contained herein. Any brand or product names mentioned herein are used for identification purposes only, and are trademarks or registered trademarks of their respective holders.

---

---

## TABLE OF CONTENTS

1.0 Introduction .....	2
2.0 Contents .....	2
3.0 Overview .....	3
3.1 Display	
3.2 Mode Keys	
4.0 Installing/Changing the batteries .....	5
5.0 Operation (LS-2000LED) .....	6
5.1 Special Functions	
6.0 Additional Operating Instruction (OT Models Only) .....	8
7.0 Safety Precautions .....	10
8.0 Slowing Down Motion .....	11
9.0 Harmonics .....	12
10.0 Determining An Object's True RPM .....	13
11.0 Multi-Key Combination Features .....	17
12.0 Specifications .....	18
13.0 Factory Default Parameter Settings .....	19
14.0 Warranty .....	20

**See page 10 for important safety precautions.**

---

---

## 1.0 INTRODUCTION

Congratulations on your purchase of a DS-2000LED or DS-2000LED-OT portable stroboscope. The strobe is used to make objects which are moving at high speeds to appear to move in slow motion or become motionless. When this occurs, you can safely and easily analyze their motion, check for proper registration, determine sources of unwanted vibration, etc.

*Typical applications include:*

- High speed assembly lines, conveyor systems, bottling operations, etc.
- Printing presses and cloth looms
- Motors, fans, pumps and turbines
- Calibration and inspection equipment
- Monitoring laboratory & research applications

### Models Available

- **DS-2000LED:** operates from Internal Rechargeable Battery or AC-Power.
- **DS-2000LED-OT:** same as above but includes external trigger output.

## 2.0 CONTENTS

- Stroboscope
- Operating manual
- Calibration certificate
- Batteries
- Case
  
- *OT Model Only:* Cable with plug for trigger signal

### 2.1 Optional Accessories

- Tripod adapter
- Tripod
- Calibration certificate
- Belt pouch

---

---

## 13.0 FACTORY DEFAULT PARAMETERS

The standard parameters on the LED Strobe are:

- |                 |                |
|-----------------|----------------|
| ■ TRIGGER       | INT (Internal) |
| ■ FPM           | 1000           |
| ■ Hz            | 16.6           |
| ■ PULSE $\mu$ m | 333            |
| ■ PULSE deg     | 2.0°           |
| ■ DELAY ms      | 0.0            |
| ■ PHASE deg.    | 0°             |
| ■ DIVIDER       | 1              |
| ■ OPTION        | 0              |

## 12.0 SPECIFICATONS

### GENERAL DATA

Protection class	IP65
Frequency range	30 – 300.000 FPM
Display	LCD, multiple lines
Accuracy	0,02% (+/- 1 digit)
Resolution	± 0,1 (30 ... 999 FPM)
Certified	CE

### FLASH PARAMETER

Flash duration	Adjustable
Light emission	3000 Lux @ 6000 FPM / 20cm (7,9 inch)
Flash color	ca. 6.500 K / Approx. 6.500 K

### POWER SUPPLY

Power supply	3 x AA size disposable batteries or 3 x NiMH rechargeable batteries
Continuous use time	NiMH: approx. 11 h @ 6.000 FPM Disposable: approx. 6 h @ 6.000 FPM

### HOUSING

Material	Aluminium / ABS Heavy duty design
Dimensions	191 x 82 x 60 mm / 7,5 x 3,2 x 2,4 inch
Weight Approx.	400g (including batteries)

### AMBIENT CONDITIONS

Temperature Range	0° ... 45° C / 32° ... 113° F
Humidity	Protection code IP65

Additional information for Stroboscope Pocket LED with trigger input and output

### TRIGGER INPUT

Principle	Optocoupler, voltage-free
Low level	< 1 V
Level	3 ... 32 V, NPN + PNP

### TRIGGER OUTPUT

Principle	Short-circuit and overvoltage proof transistor output to the optocoupler control, non-isolated
Level max.	NPR, max32V
Pulse length	Adjustable
Maximum current	50mA
Reverse voltage protection	Yes

## 3.0 OVERVIEW

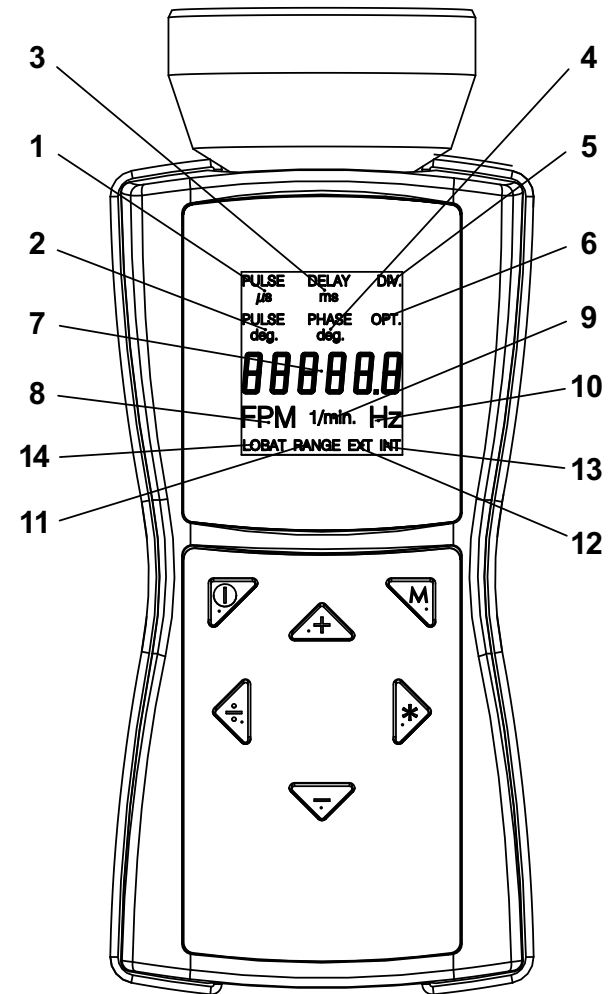



### 3.1 Display

1	<b>PULS <math>\mu</math>s</b>	Flash duration (in microseconds)
2	<b>PULS deg</b>	Flash duration (in degrees).
3	<b>DELAY ms</b>	Delay time (in milliseconds) between the internal trigger signal and the flash.





- 4 **PHASE deg** Delay time between the internal trigger signal and the flash (in degrees relative to the frequency).
- 5 **DIV** Pulse divider, maximum value 255
- 6 **OPT** Trigger signal edge selection  
0 = positive edge  
1 = negative edge
- 7 **Display** For units, see numbers 8-10.
- 8 **FPM** Flashes per minute.
- 9 **1/min** Rotations per minute
- 10 **Hz** Frequency of motion per second.
- 11 **RANGE** External trigger signal is causing the flash frequency to be too high
- 12 **EXT** External trigger signal selected
- 13 **INT** Device is generating flash frequency.
- 14 **LOBAT** Battery running low

**NOTE:** A parameter which has been set to differ from the default setting flashes during operation.

### 3.2 Mode Keys

-  **On/Off** Press and hold down the button for approx. 3 seconds
-  **Mode Button** Each time the Mode Button is pressed, the gauge switches to the next setting in the numerical order (1–10, see pages 3 & 4).

**NOTE:** Some modes only effect the functioning of the device when external triggering is employed.

-  Increases the currently set value.  
*Speeds up when this button is held down.*
-  Halves the currently set value.  
*Speeds up when this button is held down.*
-  Doubles the currently set value.  
*Speeds up when this button is held down.*
-  Lowers the currently set value.  
*Speeds up when this button is held down*

### Helpful Hints

- The most commonly used formulas are indicated by an asterisk.
- The values for “X,” “Y” and “Z” are taken in descending order. For example, the value for “X” is greater than the value for “Y.”
- The values are for successive singular harmonic images. Do not use multiple images.
- If two points are recorded, equation (1) Y gives only approximate results. Equations (2) with (4) and (3) with (5) are more precise, but error can be introduced due to the rounding.
- If three points are found, Equation (6) is the most commonly-used formula.
- For completeness, equations (9) through (21) offer mathematical derivations and condensed versions of Equation (6). Also included are the formulas for calculating  $S_x$ ,  $S_y$  and  $S_z$ .

## 11.0 MULTI-KEY COMBINATION FEATURES

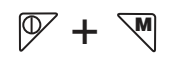
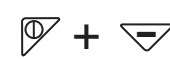
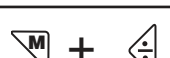
Key	Description of Functions
	Pressing both buttons simultaneously resets the gauge to its default settings.
	Pressing both buttons simultaneously activates and deactivates the Button Lock.
	Pressing both buttons simultaneously switches between internal and external trigger signals.

**Step 2:** As the flash rate is lowered, three singular harmonic images are found. (The first image at 9,600 RPM is rejected because it is a double image). Point "X" is 7,200, point "Y" is 4,800 and Point "Z" is 3,600.

**Step 3:** To calculate the true RPM, enter these values into one of the equations shown below. For this example, we will use equation (6).

$$\begin{aligned} \text{RPM} &= 2AB(A+B)/(A-B)^2 \\ &= 2 \times 2,400 \times 1,200 \times (2,400 + 1,200) / \\ &\quad (2,400 - 1,200)^2 \\ &= \mathbf{14,400} \end{aligned}$$

$$\begin{aligned} \text{Where } A &= (X - Y) \\ &= 7,200 - 4,800 \\ &= 2,400 \end{aligned}$$

$$\begin{aligned} \text{And } B &= (Y - Z) \\ &= 4,800 - 3,600 \\ &= 1,200 \end{aligned}$$

Therefore, the true speed of the object is 14,400 RPM. To help further illustrate this point, the figure below shows the harmonic relationship of the four images found in this example:

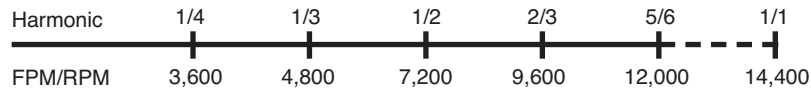

Depending on the accuracy desired, either two or three harmonic points can be found. These points are used in one of the following equations:

**If TWO points, "X" and "Y" are recorded:**

- (1) \*RPM = XY/(X-Y)
- (2) \*RPM = S<sub>X</sub>(S<sub>X</sub>+1)(X-Y)
- (3) RPM = S(S-1)(X-Y)
- (4) \*S<sub>X</sub> = Y/(X-Y), rounded
- (5) S<sub>Y</sub> = X/(X-Y), rounded

**If THREE points, "X," "Y" and "Z" are recorded:**

- (6) \*RPM = 2AB(A+B)/(A-B)<sup>2</sup>
- (7) \*A = (X-Y)
- (8) \*B = (Y-Z)

**Variations of THREE point formulas:**

- (9) \*RPM = 2PS/D<sup>2</sup>
- (10) P = Product, (A\*B)
- (11) S = Sum, (A+B)
- (12) D = Difference, (A-B)
- (13) \*S<sub>X</sub> = 2(Y-Z)/(X+Z-2Y)
- (14) S<sub>Y</sub> = (X-Z)/(X+Z-2Y)
- (15) S<sub>Z</sub> = 2(X-Y)/(X+Z-2Y)
- (16) \*S<sub>X</sub> = 2B/(A-B)
- (17) S<sub>Y</sub> = (A+B)/(A-B)
- (18) S<sub>Z</sub> = 2A/(A-B)
- (19) S<sub>X</sub> = 2B/D
- (20) S<sub>Y</sub> = S/D
- (21) S<sub>Z</sub> = 2A/D

*Formulas for calculating "Out of Range" RPMs.*

## 4.0 INSTALLING/CHANGING THE BATTERIES

1. If strobe is ON, switch the power OFF by pressing and holding the  button (see pages 3 and 4) for 3 seconds.
2. Unscrew the 2 screws at back of the strobe and remove the battery compartment cover.
3. Insert 3 new, fully charged AAA batteries into the battery compartment, following the polarity marked on the case.
4. Replace the battery cover and screws.

*Do not overtighten.*

**NOTE:** Disposable or rechargeable (NiMH) batteries may be used.



## 5.0 OPERATION

1. Make sure that the strobe has 3 charged batteries in the battery compartment; and they are aligned in the corrected polarity.
2. Aim the strobe at a moving object, then press and hold the ON/OFF Button  for approximately 3 seconds. There will be a slight delay before the strobe begins flashing. The strobe will flash at the most recently set frequency in flashes per minute, which appears on the display.

**NOTE:** If the Low Battery icon begins to flash (item **15**, page 4), replace the batteries (see section 4).

3. Press the Mode Button  to cycle through the different settings. Stop when the desired setting is highlighted on the display.

**Display fields Influencing the set signal.** Refer to figure on page 3.

- |          |              |   |
|----------|--------------|---|
| <b>1</b> | PULS $\mu$ s | Flash duration (in microseconds).   |
| <b>2</b> | PULS deg     | Flash duration (in degrees).  |
| <b>3</b> | DELAY ms     | Delay time (in milliseconds) between the internal trigger signal and the flash.                       |
| <b>4</b> | PHASE deg    | Delay time between the internal trigger signal and the flash (in degrees, relative to the frequency). |

**Units displayed.** Refer to figure on page 3.

- |           |     |                                 |
|-----------|-----|---------------------------------|
| <b>8</b>  | FPM | Flashes per minute.             |
| <b>10</b> | Hz  | Frequency of motion per second. |

### Operating information

- |           |       |                                       |
|-----------|-------|---------------------------------------|
| <b>13</b> | INT   | Device is generating flash frequency. |
| <b>14</b> | LOBAT | Battery is running low.               |

**NOTE:** A parameter which has been set to differ from the default setting flashes during operation.

**NOTE:** Pressing the  and  buttons simultaneously resets the strobe to its default settings.

**NOTE:** Some modes only effect device functioning when external triggering is employed.

**NOTE:** Static images are not only created at a precisely corresponding flash frequency, but also at multiples and fractions of this frequency.

Image No.:	<b>1</b>	<b>2</b>	<b>3</b>	<b>4</b>
				
Flash Rate:	<b>6,000</b>	<b>4,000</b>	<b>3,000</b>	<b>1,500</b>

The harmonic images at 6,000 and 4,000 RPM are not singular, but double and quadruple. A singular image does appear at 3,000 and again at 1,500 RPM. 1,500 is one half of 3,000. Therefore, the rate is 3,000 RPM.

### Example 3: (Out of Range)

This final example shows how speeds faster than 12,000 RPM (the upper limit of the Pocket-Strobe) can be calculated.

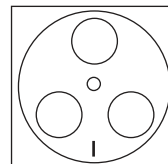





This is the object which is rotating. Its speed is known only to be greater than 12,000 RPM. Because it has a uniform shape, an orientation mark is added.

To determine its speed, three steps are required:

1. Starting from the maximum speed of the strobe, slowly reduce the flash rate. Look for singular frozen harmonic images.
2. Find at least two images. (For greater accuracy, find three). Label these rates as "X," "Y" (and possibly "Z").
3. Plug these values into a suitable equation (see page 19) and calculate the object's RPM.

**Step 1:** As the speed is reduced, the following images appear:

Image No.:	<b>1</b>	<b>2</b>	<b>3</b>	<b>4</b>
				
Flash Rate:	<b>9,600</b>	<b>7,200</b> Point "X"	<b>4,800</b> Point "Y"	<b>3,600</b> Point "Z"

What is the actual rate of the fan? Images 1, 3, 5, 7, and 8 are all “frozen,” so the rate could be taken as 3,300, 1,100, 825, 660 or 550. Which is correct?

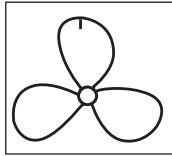

In order to determine the fan’s actual speed, a mark is added to one of the blades and the test is run again.

Image No.:	1	2	3	4
Flash Rate:	3.300	1,650	1,100	916.6

---

Image No.:	5	6	7	8
Flash Rate:	825	733.3	660	550

Using the orientation mark, it is now clear that the images appearing at 3,300, 825 and 660 RPM are multiple-image harmonics. In each of these cases, three identification marks appear. On the other hand, a singular image appears at 1,100 and again at 550.

Here, only one mark appears. Recall that “a singular image always appears at exactly one half of the object’s true RPM.” 550 is one half of 1,100. Therefore, the rate of the fan must be 1,100 RPM.

### Example 2: (Within Range No Mark Needed)

This example illustrates how the actual speed of an object can be determined without the use of an orientation mark—provided that the object has a suitable shape.

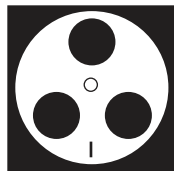

Assume that the speed of this cam is known only to be less than 7,000 RPM. Because it has a unique shape, it does not need an identifying mark. As the flash rate is lowered from 7,000, the following harmonic images appear.

- If the flash frequency corresponds to the motion frequency, a static image will be created. If the image does not appear static (motionless), adjust the flash frequency using the Adjustment Buttons as indicated below

Increases the currently set value.  
*Speeds up when this button is held down.*

Halves the currently set value.  
*Speeds up when this button is held down.*

Doubles the currently set value.  
*Speeds up when this button is held down.*

Lowers the currently set value.  
*Speeds up when this button is held down.*



**CAUTION:** Although the object may appear to be motionless, it is still moving and should NEVER be touched.

- The following functions are activated by simultaneously pressing the buttons shown below:

+ = Reset to default settings

+ = Activate/Deactivate Button Lock.

*Prevents current settings from being changed accidentally*

### 5.1 Using Special Functions

#### PULS $\mu$ s/PULS deg:

Flash duration. This function enables you to set the flash duration. Using this function, you can influence the brightness and focus of the object of observation. This adjustment can either be made in absolute form (microseconds) or in relative form (degrees).

#### DELAY ms

Adjustment of delay time between the internal trigger signal and the flash (in milliseconds). This function enables you to set a fixed delay time between the internal trigger signal and the flash.

**Example:** The position of observation can be adjusted extremely precisely without altering the flash frequency. You can shift the observation position within a motion cycle.

#### PHASE deg

Phase shift adjustment between the internal trigger signal and the flash (in degrees, relative to the frequency). This function enables you to set a fixed angle between the internal trigger signal and the flash.

**Example:** The position of observation can be adjusted extremely precisely without altering the flash frequency. You can shift the observation position within a motion cycle.

## 6.0 ADDITIONAL OPERATING INSTRUCTIONS (OT MODEL ONLY)

1. Press the  and  buttons simultaneously to switch between internal and external trigger signal.



**CAUTION:** Do not use signals over 300,000 FPM Hz to trigger the device.

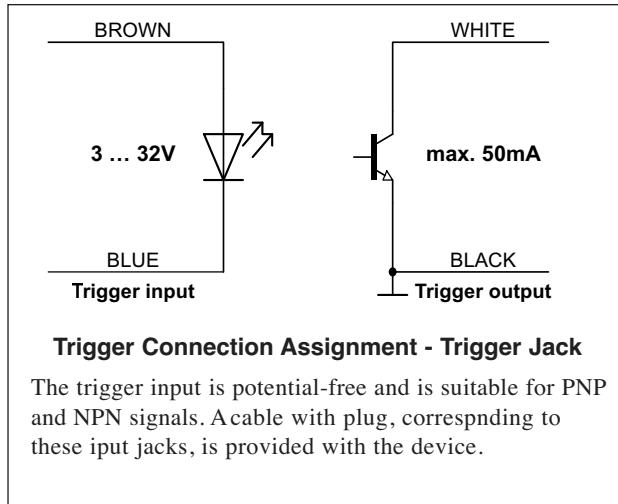

Display fields (see pages 3 and 4)

Influencing the input signal before the flash is generated

- |   |           |   |
|---|-----------|---|
| 3 | DELAY ms  | Adjustment of delay time (in milliseconds) between the internal trigger signal and the flash.                     |
| 4 | PHASE deg | Phase shift adjustment between the internal trigger signal and the flash (in degrees, relative to the frequency). |
| 5 | DIV       | Pulse divider, maximum value 255.   |
| 6 | OPT       | Trigger signal edge selection<br>0 = positive edge<br>1 = negative edge   |

## 10.0 DETERMINING AN OBJECT'S TRUE RPM

The strobe can be used as a digital tachometer to determine the true RPM and/or the reciprocation rate of an object. This is done by visually "freezing" the object's movement and then reading the LCD display. As with all stroboscopes, it is important to verify that this frozen image is not a harmonic of the object's actual rate.

### Helpful Hints



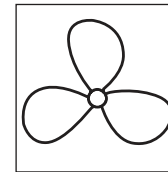

- Knowing the approximate rate of the object in advance gives you a useful starting point.
- If the object has a uniform shape, like a multi-blade fan or motor shaft, you must give it an identifying mark (using paint or reflective tape or equivalent) in order to differentiate its orientation.
- A singular image always appears at exactly one half of the object's true RPM.
- Mathematical harmonic techniques can be used to determine an object's true RPM if it is greater than the upper limit of the stroboscope. See Example 3 on page 15.

### Example 1 (Within Range):







*This example shows why identifying marks are important.*

Suppose you want to determine the true RPM of this fan. The only thing you know is that its speed is less than 3,500 RPM. If you slowly decrease the flash rate starting from 3,500 FPM, the following "frozen" images appear:

Image No.:	1	2	3	4
				
Flash Rate:	3,300	1,650	1,100	916.6

---

Image No.:	5	6	7	8
				
Flash Rate:	825	733.3	660	550



---

---

## 9.0 HARMONICS

If you continuously increase the flash rate while strobing an object, it may appear to freeze, slow down, speed up, go forward, freeze again, go backwards, form multiple images, etc. These images appear at mathematically determined multiples or harmonics of the object's actual speed.

**Example:** Assume you wish to slow the motion of the fan used in the last example, but you want it to be brighter.

**Technique:** Starting from 1,000 FPM, slowly increase the flash rate. At 1,500 FPM the image will appear to freeze again. Continue to increase the rate. The image will appear to freeze again at 3,000 FPM. At this rate, the fan appears to be very bright.

### Helpful Hint:

- Harmonic images appear at both whole number multiples as well as fractional intervals of the object's actual rate. For example, a fan rotating at 1,000 RPM will appear to be frozen at the whole number multiples of 2,000 (2x), 3,000 (3x), 4,000 (4x) etc., as well as at the fractional rates of 500 (1/2x), 750 (3/4x), 833 (5/6x) and 1,500 (1 1/2x), etc.
- Some of the harmonic images are "singular" in appearance while others are "multiple." This becomes important if you want to determine the objects actual rate as discussed in section 10.0.

---

---

### Unit displayed

**9** 1/min Rotations per minute.

**10** Hz Frequency of motion per second.

**NOTE:** When an external trigger signal is used, the units 1/min (rather than FPM) or Hz are displayed.

### Operating information

**11** RANGE External trigger signal is causing the flash frequency to be too high.

**12** EXT External trigger signal selected.

**13** INT Device is generating flash frequency.

**NOTE:** A parameter which has been set to differ from the default setting flashes during operation.

## 6.1 Using Special Functions (OT model)

### DELAY ms

Adjustment of delay time between the internal trigger signal and the flash (in milliseconds). This function enables you to set a fixed delay time between the input signal and the output signal.

*Example:* The external trigger signal is generated before the required observation point (= flash position of the stroboscope). In this case the connected stroboscope would regularly flash too soon. With the DELAY ms function, you can set the value by which the output signal should be delayed.

### PHASE deg

Phase shift adjustment between the internal trigger signal and the flash (in degrees, relative to the frequency). This function enables you to set a fixed angle between the internal trigger signal and the flash.

*Example:* The external trigger signal is generated before the required observation point (= flash position of the stroboscope). In this case the connected stroboscope would regularly flash too soon. With the PHASE deg function, you can adjust the delay so that the flash position of the stroboscope is altered by a set angle. This setting is independent of the current speed of rotation, which means that the stroboscope will flash at the required position even during the start-up process or when the speed of rotation is fluctuating.

### DIV (pulse divider)

This function is only active when an external trigger signal is employed. With the pulse divider you can set a value x, by which the external trigger signal is then divided.

*Example:* An external trigger (e.g. rotation sensor) scanning a gear wheel issues a signal for every tooth scanned. At a DIV value of 10, only every tenth input pulse is transmitted to the connected stroboscope as a trigger signal.

### OPT

Trigger signal edge selection. 0 = positive edge, 1 = negative edge. With this option, the polarity of the trigger signal can be defined.

## 7.0 SAFETY PRECAUTIONS



- Stroboscopes give the illusion of stopped motion. Do not touch the machine or object being observed.
- The use of stroboscopes may induce an epileptic seizure in those persons predisposed to this type of attack.
- Do not use this product in an explosive environment.
- Do not use this product in wet or condensating environments.
- Do not allow liquids or metallic objects to enter into the ventilation holes.
- Wear adequate eye protection when using this product. Failure to do so could result in serious injury.
- The DS-2000LED / DS-2000LED-OT are designed for battery operation only. Do not operate the instrument while it is recharging. Failure to follow these instructions will damage the unit and void its warranty.



### DANGER HIGH VOLTAGE!

To reduce risk of an electronic shock, do not open the stroboscope. There are no user-serviceable parts inside.

## 8.0 SLOWING DOWN MOTION

As discussed, the primary use of the strobe is to slow down or “freeze” the apparent motion of moving objects. This allows you to analyze their run-time performances safely and easily.

To make an object appear to move in slow motion, you need to strobe it at a rate slightly above or slightly below its actual speed or any harmonic of its speed as discussed below.

### Helpful Hints:

The speed at which the object appears to move can be determined by subtracting the flash rate from the object’s actual rate.

**Example:** If an object is rotating at 1,000 RPM and you strobe it at a rate of 1,005 flashes per minute (FPM), the object will appear to be moving at a rate of 5 RPM.

$$\begin{aligned}\text{Speed} &= \text{Actual Rate minus Flash Rate} \\ &= 1,000 - 1,005 = 5 \\ &= \mathbf{5 \text{ RPM}}\end{aligned}$$

The direction (clockwise vs. counterclockwise or forward vs. backward) at which the object appears to move is determined by the flash rate, the object’s actual direction of movement and the orientation of the stroboscopic beam to the object.

**Example:** Assume you wish to visibly slow down the movement of a fan which is rotating clockwise at 1,000 RPM.

*Case 1:* If you stand in front of it and strobe it at a rate of 1,005 flashes per minute (FPM), the object will appear to be moving at a rate of 5 RPM in a counterclockwise direction.

*Case 2:* If you stand in front of it and strobe it at a rate of 995 FPM, it will appear to move at a rate of 5 RPM in a clockwise direction.

*Case 3:* If you stand behind it and strobe it at a rate of 1,005 FPM, it will appear to move in a clockwise direction at a rate of 5 RPM.

*Case 4:* If you stand behind it and strobe it at a rate of 995 FPM, it will appear to move in a counterclockwise direction at a rate of 5 RPM

**NOTE:** Typically, stroboscopes are brightest (and can illuminate an object the best) when the flash rate is between 2,000 and 6,000 FPM. Often, you can still make an object appear to be frozen or moving in slow motion within this range because of the effect of harmonics. This principle is explained section 9.0.

Pocket  
**STROBOSCOPE**

Models DS-2000LED / DS-2000LED-OT



OPERATING MANUAL



**ELECTROMATIC**  
EQUIPMENT CO., INC.

600 Oakland Ave., Cedarhurst, NY 11516-U.S.A.  
TEL: 516-295-4300 • FAX: 516-295-4399