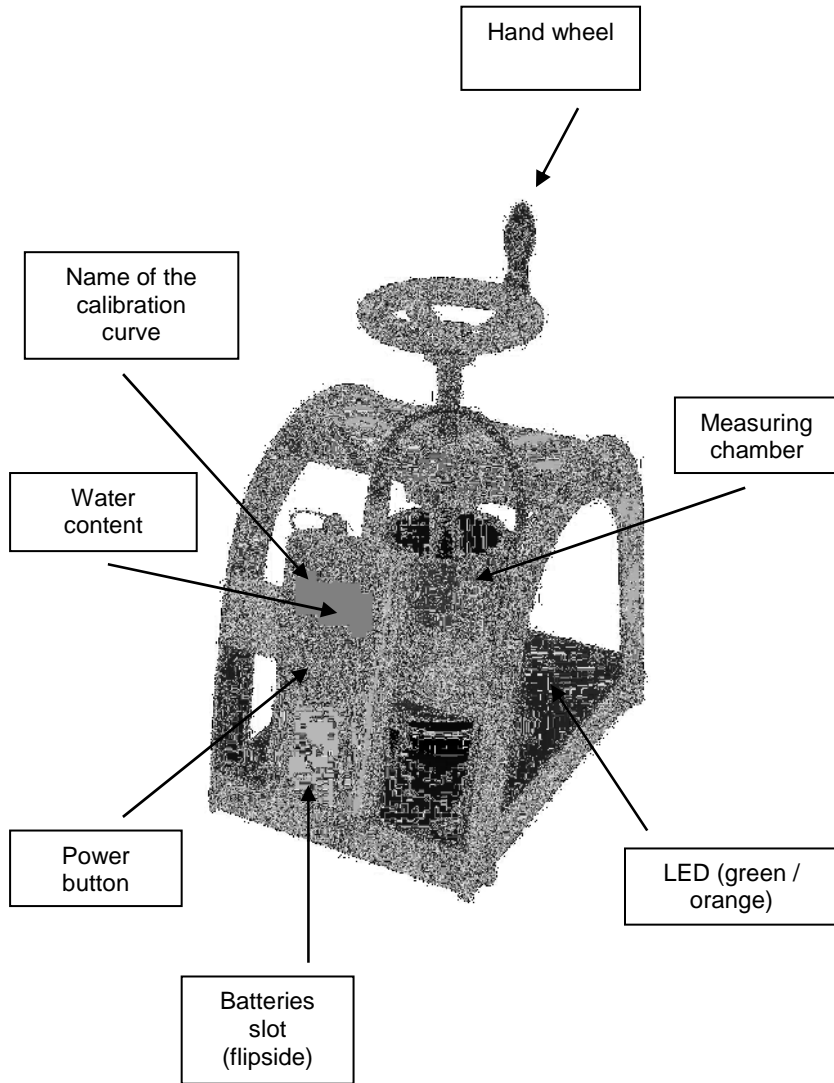

NOTE

TABLE OF CONTENTS

1.0	Design of the device	2
2.0	Measuring procedure	3
2.1	Information of the measurement of sawdust	
3.0	Calibration curves	6
4.0	Determination of the material reference moisture	6
5.0	Menu level overview	7
6.0	Changing batteries	8
7.0	Transfer saved data to the PC	9
8.0	Print saved data	10
9.0	Online print and online send	10
10.0	Device maintenance instructions	11
11.0	Exemption from liability	11
12.0	Technical data	12
13.0	Most common reasons for miss readings	13
14.0	Warranty	14

1.0 DESIGN OF THE DEVICE

NOTE



14.0 WARRANTY

Electromatic Equipment Co., Inc. (Electromatic) warrants to the original purchaser that this product is of merchantable quality and confirms in kind and quality with the descriptions and specifications thereof. Product failure or malfunction arising out of any defect in workmanship or material in the product existing at the time of delivery thereof which manifests itself within one year from the sale of such product, shall be remedied by repair or replacement of such product, at Electromatic's option, except where unauthorized repair, disassembly, tampering, abuse or misapplication has taken place, as determined by Electromatic. All returns for warranty or non-warranty repairs and/or replacement must be authorized by Electromatic, in advance, with all repacking and shipping expenses to the address below to be borne by the purchaser.

THE FOREGOING WARRANTY'S IN LIEU OF ALL OTHER WARRANTIES, EXPRESSED OR IMPLIED, INCLUDING BUT NOT LIMITED TO, THE WARRANTY OF MERCHANTABILITY AND FITNESS FOR ANY PARTICULAR PURPOSE OR APPLICATION. ELECTROMATIC SHALL NOT BE RESPONSIBLE NOR LIABLE FOR ANY CONSEQUENTIAL DAMAGE, OF ANY KIND OR NATURE, RESULTING FROM THE USE OF SUPPLIED EQUIPMENT, WHETHER SUCH DAMAGE OCCURS OR IS DISCOVERED BEFORE, UPON OR AFTER REPLACEMENT OR REPAIR, AND WHETHER OR NOT SUCH DAMAGE IS CAUSED BY MANUFACTURER'S OR SUPPLIER'S NEGLIGENCE WITHIN ONE YEAR FROM INVOICE DATE.

Some State jurisdictions or States do not allow the exclusion or limitation of incidental or consequential damages, so the above limitation may not apply to you. The duration of any implied warranty, including, without limitation, fitness for any particular purpose and merchantability with respect to this product, is limited to the duration of the foregoing warranty. Some states do not allow limitations on how long an implied warranty lasts but, notwithstanding, this warranty, in the absence of such limitations, shall extend for one year from the date of invoice.

Electromatic Equipment Co., Inc.
600 Oakland Ave. Cedarhurst, NY 11516 - USA
Tel: 1-800-645-7330 / Tel: 516-295-4300 / Fax: 516-295-4399

Every precaution has been taken in the preparation of this manual. Electromatic assumes no responsibility for errors or omissions. Neither is any liability assumed for damages resulting from the use of information contained herein. Any brand or product names mentioned herein are used for identification purposes only, and are trademarks or registered trademarks of their respective holders.

2.0 MEASURING PROCEDURE

1. Switch on the humimeter BLH by pressing the power button (⏻) for 3 sec.



2. Select the right calibration curve for your material under test using the buttons ▲ or ▼.

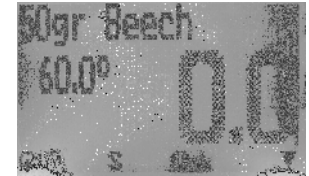

3. Place the scale on an even surface. Place the humimeter BLH in the centre of the scale. Zero the scale to show 0.0g.



4. Fill the measuring chamber with the appropriate amount of wood shavings. The cup must be filled either 50g or 100g material. During filling the cup, the material must not be compressed too much. If you have no place in the cup for 100g, the cup must be emptied again and 50g wood chips have to be filled into the cup.







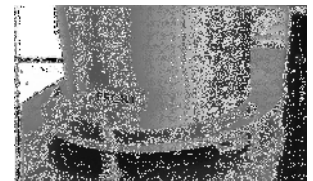

CAUTION: Excessive force may be destroyed: the cup!

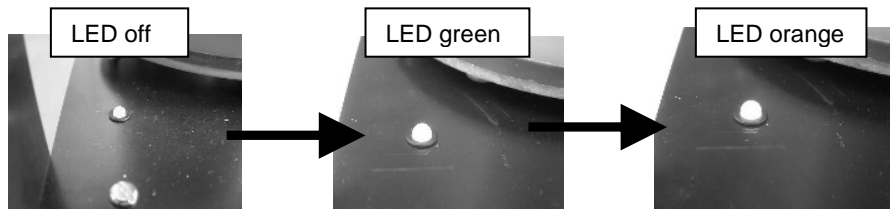
5. Put the measuring chamber into the device. The sticker has to be facing the electronics housing.



- Compress the material in the measuring chamber now by turning the hand wheel (1 turn per second) until the LED turns green. Now slowly (0.5 turns per second) must be rotated until the LED flashes orange once.



- Then immediately press the start button on the device
- After a few seconds, the display shows stable **water** content.
- The water content of the sample is now visible on the display.
- If the measure value is blinking, the valid measuring range is exceeded (limits see list on page 5). In this case the accuracy will be decreasing.
- To save the results in the save menu press the  button. The storage was successful when the number in front of the symbol  increased. To reach the store menu please press  until the  appears.
- To name the saved results press the  button.
- Empty the humimeter BLH and ensure that no material rests are accumulated in the measuring chamber.

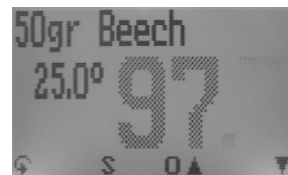
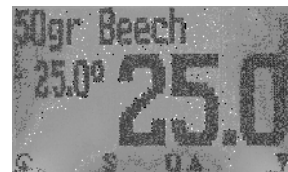

13.0 MOST COMMON REASONS FOR MISS READINGS

- Product temperature out of application range**
Material **below 0°C** resp. **above +40°C** (32 to 104 °F) may cause faulty measurements. The storage of cold material in a warm storage area usually creates condensed water which may lead to major measuring errors.
- Not adjusted material under test**
Please ensure that the device and the material under test are being stored at the same temperature (+/-3°C) before measuring. A very high temperature difference has a negative effect on the stability of the measurement results.
- Wrong calibration curve**
Before you measure your sample, double check the correct selection of the calibration curve.
- Wrong filling quantity**
Fill in exactly the right weight of wood chips in the measuring chamber.
- Wet or moldy material**
- Frozen measuring material**
- The steel plate which is mounted on the spindle part** has to be cleaned at regular intervals. As well as the pressure pin on the base plate (use a dry cloth or something like that). Specifically, after measurement of wet material can be located on the disk. This material can interfere with the following measurements!
- Compression function has to be done smoothly**
To compress the hand wheel approximately one turn per second should be rotated. When the green LED is on, the hand wheel has to be turned a half turn further per second until the LED is orange is on.

12.0 TECHNICAL DATA

Resolution of the display	0.5% water content 0.5°C temperature
Measuring range	15 up to 65% depending on the material
Operation temperature	0°C up to +40°C
Storage temperature	-20°C to +60°C
Temperature compensation	Automatically
Power supply	4 pcs. 1.5 Volt AA Alkaline batteries (900 measurements)
Auto Switch OFF	After app. 6 minutes (adjustable)
Current consumption	60mA (with light)
Display	128 x 64 matrix display, lighted
Dimensions	275 x 180 x 290 mm
Weight	ca. 2,9 kg (including batteries)
Degree of protection	IP 40
Scope of supply	Device including measuring cup 4x1.5 Volt AA Alkaline batteries Software LogMemorizer USB interface for PC transfer USB cable

2.1 Information of the measurement of sawdust

Enclosed you will find instructions for measuring sawdust. If you are not sure what type of wood you use, we recommend a one-time measurement compared with the drying method according CEN / TS 14774.

The calibration curves using 100g filling quantity only be used in very wet material. In general, the sample size of 50gr has to be used. If at the 50gr curve to less pressure is in the measuring cup (LED don't lights up orange!), than the 100gr calibration curve must be used.

Material less than 15% water content cannot be measured.

Information: It is possible that other calibration curves (e.g., other types of wood, defined mixtures, etc.) are calibrated by the Schaller GmbH in the humimeter device.

3.0 CALIBRATION CURVES

Type of wood	Filling quantity	Measuring range
Beech	50 g	15 % to 45%
Beech	100 g	40 % to 60 %
Birch	50 g	15 % to 45%
Birch	100 g	35 % to 55%
Oak	50 g	15% to 45%
Oak	100 g	40% to 55%
Spruce	50 g	15% to 60%
Spruce	100 g	50% to 65%
Poplar	50 g	15% to 60%
Poplar	100 g	50% to 60%
Reference	-----	-----

To verify the calibration curve only the standardized drying method is permissible because many other methods used are doubtful and can lead to incorrect comparison values. If no existing curve fit, then a calibration by the company Schaller is required.

4.0 DETERMINATION OF THE MATERIAL REFERENCE MOISTURE

The principle is a comparison measurement with the dehydration method according to CEN/TS 14961:2005. Take the measured sample and weigh it. Dry it out in an oven and weigh it again.

$$\% F = \frac{M_n - M_t}{M_n} \times 100$$

M_n : Mass with average moisture content

M_t : Mass of the dried sample

%F: Calculated moisture content

10.0 DEVICE MAINTENANCE INSTRUCTIONS

To provide a long life of your device please does not expose it to strong mechanical loads or heat e.g. dropping it or direct sunlight exposure. Clean your device using a dry cloth. Any kind of wet cleaning damages the device.

It is not allowed to load the measuring head incorrect (stress, bending), otherwise it can be broken. Plug and remove the insertion probe of your BLH straight into the wood chips.

The instrument is not rainproof. Keep it in dry areas. When the device isn't used for a longer period (2 months) or when the batteries are empty, they should be removed to prevent a leakage of the battery acid.

11.0 EXEMPTION FROM LIABILITY

For miss readings and wrong measurements and of this resulting damage we refuse any liability. This is a device for quick determination of moisture. The moisture depends on multiple conditions and multiple materials. Therefore we recommend a plausibility check of the measuring results. Each device includes a serial number and the guarantee stamp. If those are broken, no claims for guarantee can be made. In case of a faulty device, please contact Checkline Europe (www.checkline-europe.eu) or our dealer.

8.0 PRINT SAVED DATA

To print your saved data, connect the device to the printer using the printer cable that was delivered with your device. Carefully loose the protection cap on the humimeter BLH. At first plug in the side of the connector with the close plastic casing at the humimeter BLH. Then switch on the device.

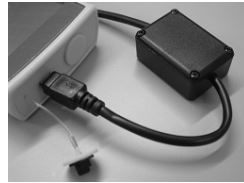

Not till then the other side of the cable has to be plugged in at the printer. Switch on the printer by pressing . Now the green LED is blinking. If it does not blink, please change the batteries and try again.

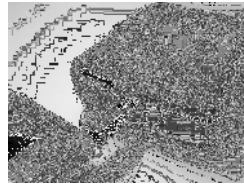

Press the button at your humimeter until you reach the menu (see image on the right). Choose „Print Logs“ and confirm by pressing .

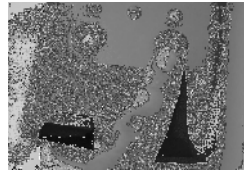

Now you can select if you want to print the last saved measuring series or all saved measuring series (logs).

Confirm by pressing again. The selected logs are printed out now.



To save paper, please think of clearing the data storage regularly.

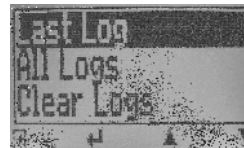

9.0 ONLINE PRINT AND ONLINE SEND

Your device supports the function “Online Print” and “Online Send”, this can be activated in the menu „Options“. If an option is active, every newly recorded log will immediately be printed or transferred to the PC after pressing key.



5.0 MENU LEVEL OVERVIEW

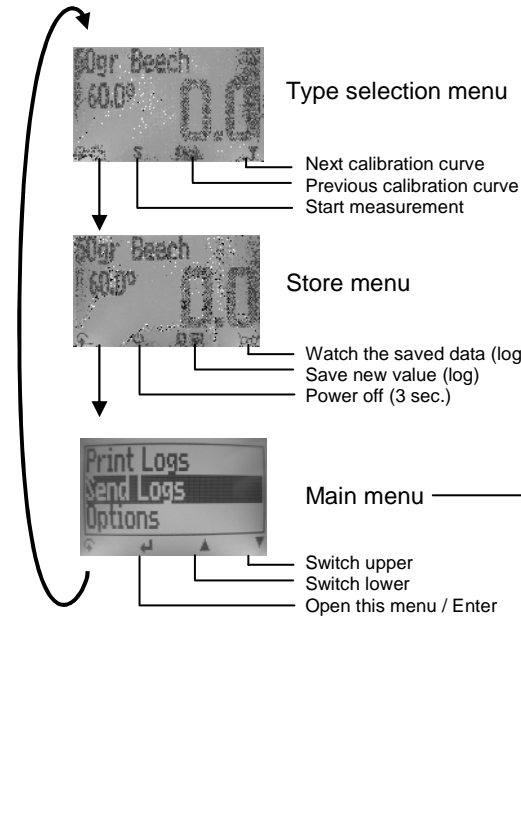

Keypad symbols

- Measuring window:**
- Rolling Menu
 - Power ON / OFF
 - Switch upper
 - Switch lower
 - Save
 - Hold
 - Watch the saved data
 - Suppliers data can be added
 - Rotate display
- Menu:**
- Enter
 - Switch upper
 - Switch lower
 - Exit
 - Enter numbers
 - Enter letters
 - Next or right
 - Left
 - Yes
 - No
 - Shift
 - OK

Overview main menu

Edit Logs	Options
Manual Logs	Date / Time
Clear Logs	Log Time
Print Logs	Language
Last Log	Unlock
All Logs	°C / °F
Clear Logs	o Userlevel
Send Logs	BL On Time
Manual Logs	Auto Off Time
Clear Logs	Materialcalib.
Options	o Online Send
Status	o Online Print
	Password
	Reset

6.0 CHANGING BATTERIES

Please find enclosed the manual for changing of batteries:

1. Press with your finger onto the arrow of the battery cap and pull it back.
2. Remove the empty batteries.
3. Put four new batteries in the device. Make sure that the position of the battery poles is correct.
4. Press down the batteries and close the cap.

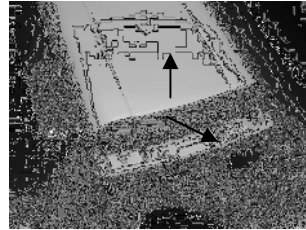

If the battery symbol appears in the measuring window resp. if a critical charge of battery is shown in the status, the batteries have to be changed IMMEDIATELY. If you do not use your humimeter device for a longer period, remove the batteries. For eventual resulting damages we cannot provide any warranty.



7.0 TRANSFER SAVED DATA TO THE PC



To send your saved logs to the PC, connect the humimeter device to your PC using the USB cable that was delivered with your device. Carefully loose the protection cap on your humimeter and plug in the USB mini B connector. The bigger connector has to be connected to a USB slot on your PC.



Start the LogMemorizer software on your PC and switch on your humimeter BLH. The data transfer can be started on your humimeter or on the software.



Starting the data transfer on the humimeter:

Press the  key until you reach the menu (see image on the right). Then choose „Send Logs“ and confirm by pressing the  key. Now choose „Manual Logs“ and confirm with  again. All saved logs will be sent to your PC.



Starting the data transfer on your PC:

Press the button „remote control“ in the LogMemorizer software. A drop-down menu with several options opens (see image below).

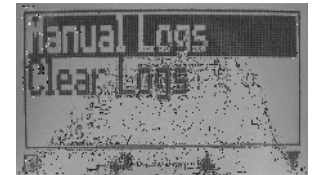

For transferring the data you can select „Import last manual log“ (the last saved measuring series is transferred) or „Import all manual logs“ (all saved logs are transferred).



If you click on one of these menu items, the transfer starts immediately.

For the basic adjustments of the software please look through the instructions on the LogMemorizer CD.



BLH

WOOD SHAVINGS MOISTURE METER

