

Series **3**

DIGITAL FORCE GAUGES

User's Guide

Thank you...



Thank you for purchasing a Mark-10 Series 3 digital force gauge, designed for tension and compression force testing applications from 0.12 lb to 500 lb (0.5 N to 2,500 N) full scale. The Series 3 is an essential component of a force testing system, typically also comprising a test stand, grips, and data collection software.

With proper usage, we are confident that you will get many years of great service with this product. Mark-10 force gauges are ruggedly built for many years of service in laboratory and industrial environments.

This User's Guide provides setup, safety, and operation instructions. Dimensions and specifications are also provided. For additional information or answers to your questions, please do not hesitate to contact us. Our technical support and engineering teams are eager to assist you.

Before use, each person who is to use the Series 3 force gauge should be fully trained in appropriate operation and safety procedures.

TABLE OF CONTENTS

OVERVIEW	2
POWER	3
MECHANICAL SETUP	4
HOME SCREEN AND CONTROLS	5
OPERATING MODES	7
CHANGING THE UNITS	7
DIGITAL FILTERS	7
SET POINT INDICATORS	8
COMMUNICATIONS	9
CALIBRATION	12
OTHER SETTINGS	16
SPECIFICATIONS	19

1 OVERVIEW

1.1 List of included items

Qty.	Part No.			Description
	M3-012 – M3-20	M3-50 – M3-100	M3-200 – M3-500	
1	12-1049	12-1049	12-1049	Carrying Case
1	AC1030 / AC1031 / AC1032	AC1030 / AC1031 / AC1032	AC1030 / AC1031 / AC1032	AC adapter body with US, EU, or UK prong
1	08-1026	08-1026	08-1026	Battery (inside the gauge)
1	G1024	G1024	G1031	Extension rod
1	G1026	G1026	G1033	Cone
1	G1025	G1025	G1032	Chisel
1	G1027	G1027	G1034	V-groove
1	G1029	G1029	G1036	Flat
1	G1028	G1038	G1035	Hook
1	N/A	G1039	G1037	Coupling
1	-			Certificate of calibration
1	09-1165			USB cable
1	-			Resource CD (USB driver, user's guides, MESUR Lite software, MESURgauge DEMO software, User's Guide)

1.2 Safety / Proper Usage

Caution!

Note the force gauge's capacity before use and ensure that the capacity is not exceeded. Producing a force greater than 150% of the gauge's capacity can damage the internal load cell. An overload can occur whether the gauge is powered on or off.

Typical materials able to be tested include many manufactured items, such as springs, electronic components, fasteners, caps, films, mechanical assemblies, and many others. Items that should not be used with the gauge include potentially flammable substances or products, items that can shatter in an unsafe manner, and any other components that can present an exceedingly hazardous situation when acted upon by a force.

The following safety checks and procedures should be performed before and during operation:

1. Never operate the gauge if there is any visible damage to the AC adapter or the gauge itself.
2. Ensure that the gauge is kept away from water or any other electrically conductive liquids at all times.
3. The gauge should be serviced by a trained technician only. AC power must be disconnected and the gauge must be powered off before the housing is opened.
4. Always consider the characteristics of the sample being tested before initiating a test. A risk assessment should be carried out beforehand to ensure that all safety measures have been addressed and implemented.
5. Wear eye and face protection when testing, especially when testing brittle samples that have the potential to shatter under force. Be aware of the dangers posed by potential energy that can

accumulate in the sample during testing. Extra bodily protection should be worn if a destructive failure of a test sample is possible.

6. In certain applications, such as the testing of brittle samples that can shatter, or other applications that could lead to a hazardous situation, it is strongly recommended that a machine guarding system be employed to protect the operator and others in the vicinity from shards or debris.
7. When the gauge is not in use, ensure that the power is turned off.

2 POWER

The gauge is powered either by an 8.4V NiMH rechargeable battery or by an AC adapter. Since these batteries are subject to self discharge, it may be necessary to recharge the unit after a prolonged period of storage. Plug the accompanying charger into the AC outlet and insert the charger plug into the receptacle on the gauge (refer to the illustration below). The battery will fully charge in approximately 8 hours.

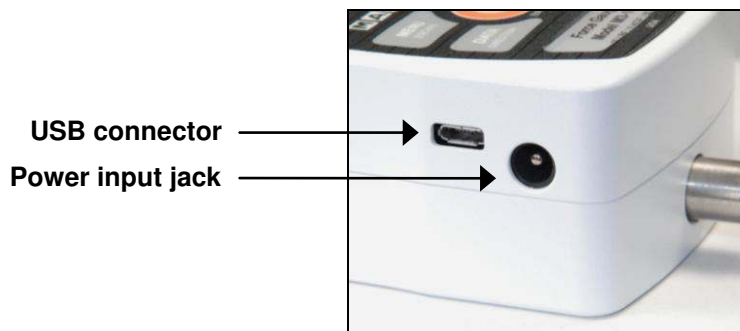





Caution!

Do not use chargers or batteries other than supplied or instrument damage may occur.

If the AC adapter is plugged in, an icon appears in the lower left corner of the display, as follows: 

If the AC adapter is not plugged in, battery power drainage is denoted in a five-step process:

1. When battery life is greater than 75%, the following indicator is present: 
2. When battery life is between 50% and 75%, the following indicator is present: 
3. When battery life is between 25% and 50%, the following indicator is present: 
4. When battery life is less than 25%, the following indicator is present: 
5. When battery life drops to approximately 2%, the indicator from step 4 will be flashing. Several minutes after (timing depends on usage and whether the backlight is turned on or off), a message will appear, "BATTERY VOLTAGE TOO LOW. POWERING OFF". A 4-tone audio indicator will sound and the gauge will power off.

The gauge can be configured to automatically power off following a period of inactivity. Refer to the **Other Settings** section for details.

If battery replacement is necessary, the battery may be accessed by separating the two halves of the gauge. Refer to the **Mechanical Setup** section for details.

3 MECHANICAL SETUP

3.1 Loading shaft orientation

In order to accommodate a variety of testing requirements, the orientation of the loading shaft may be set up in either of the two positions shown below. In order to change the loading shaft orientation, loosen the two captive screws on the back side of the housing, separate the two housing halves, rotate one half 180 degrees, and reassemble. Exercise care when reassembling the two halves of the housing, ensuring that internal wires do not interfere.

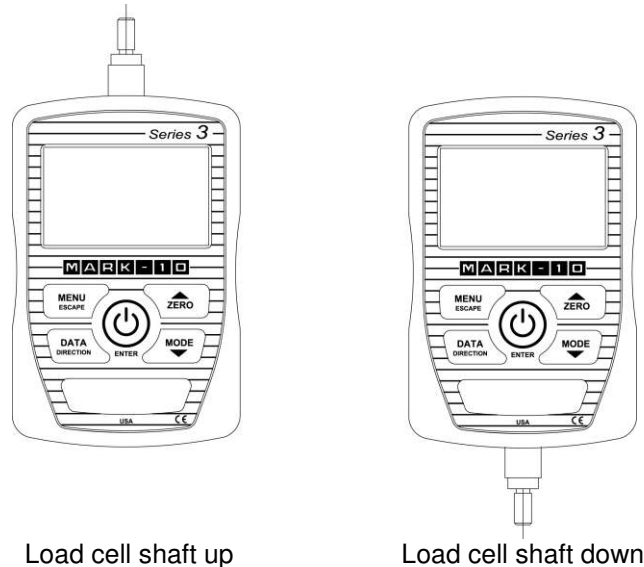

Load cell shaft up

Load cell shaft down

3.2 Mounting to a plate

Although the gauge may be used by hand, proper mounting is important if attached to a fixture or test stand. The round steel insert with a hole in the back of the housing is provided to withstand the load during a test. A mating dowel pin should be used (see illustration below). Mounting plates on Mark-10 test stands include a dowel pin and clearance holes for the four threaded holes located near the corners of the housing. An additional two holes are supplied for metric screws. These holes are designed to accommodate screws in order to hold the gauge in place (Mark-10 test stands include a set of thumb screws for gauge mounting). The screws must **not** be used for load bearing purposes. Failure to use a dowel pin properly can result in a hazardous situation.

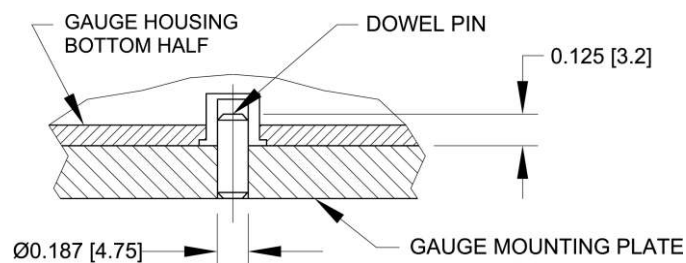

3.3 Mounting attachments to the gauge

The force gauge's threaded loading shaft is designed to accommodate common grips and attachments with female mounting holes. To mount a grip, gently thread it onto the shaft. Other mounting adapters are also available to prevent rotation. Ensure that the grip or fixture is positioned to ensure axial load with respect to the loading shaft of the force gauge. When using a grip, ensure that it secures the sample in such a way that it is prevented from slipping out during a test, preventing a potential safety risk to the



operator and others in the vicinity. If using a grip or fixture from a supplier other than Mark-10, ensure that it is constructed of suitably rugged materials and components.

Do not use jam nuts or tools to tighten grips or attachments onto the shaft. **Finger-tighten only.**

4 HOME SCREEN AND CONTROLS

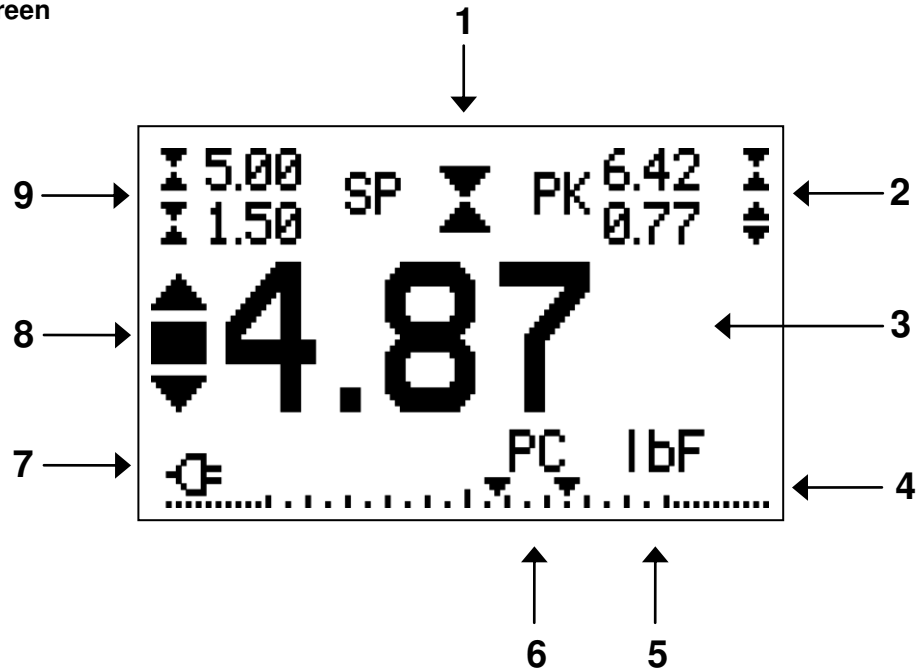

4.1 Home Screen



No.	Name	Description
1	Tension / compression indicator	<p>  - indicates a compression (push) direction  - indicates a tension (pull) direction These indicators are used throughout the display and menu. </p>
2	Peaks	The maximum measured compression and tension readings. These readings are reset by pressing ZERO or by powering the gauge off and on.
3	Primary reading	The current displayed force reading. See Operating Modes section for details.
4	Load bar	Analog indicator to help identify when an overload condition is imminent. The bar increases either to the right or to the left from the midpoint of the graph. Increasing to the right indicates compression load, increasing to the left indicates tension load. If set points are enabled, triangular markers are displayed for visual convenience. This indicator reflects the actual load, which may not correspond to the primary reading (depends on operating mode). The ZERO key does not reset the load bar. See Operating Modes section for details.
5	Units	<p>The current measurement unit. Abbreviations are as follows:</p> <ul style="list-style-type: none"> lbF – Pound-force kgF – Kilogram-force gF – Gram-force N – Newton <p>Note: not all gauge capacities measure in all the above units. Refer to the capacity / resolution table in the Specifications section for details.</p>

6	Mode	The current measurement mode. Abbreviations are as follows: RT – Real Time PC – Peak Compression PT – Peak Tension See Operating Modes section for details about each of these modes
7	Battery / AC adapter indicator	Either the AC adapter icon or battery power icon will be shown, depending on power conditions. Refer to the Power section for details.
8	High / low limit indicators	Correspond to the programmed set points. Indicator definitions are as follows: ▲ – the displayed value is greater than the upper force limit ■ – the displayed value is between the limits ▼ – the displayed value is less than the lower force limit
9	Set points	The programmed force limits. Typically used for pass/fail type testing. 1, 2, or no indicators may be present, depending on the configuration shown in the Set Points menu item.

4.2 Controls

Primary Label	Primary Function	Secondary Label	Secondary Function
	Powers the gauge on and off. Press briefly to power on, press and hold to power off. Active only when the home screen is displayed.	ENTER	Various uses, as described in the following sections.
ZERO	Zeroes the primary reading and peaks.	 (UP)	Navigates up through the menu and sub-menus .
MENU	Enters the main menu.	ESCAPE	Reverts one step backwards through the menu hierarchy.
MODE	Toggles between measurement modes.	 (DOWN)	Navigates down through the menu and sub-menus.
DATA	Transmits the current reading to an external device, via the USB port.	DIRECTION	Reverses the display during calibration, and toggles between tension and compression directions while configuring set points and other menu items.

Note: Measurement units are configured through the menu. Refer to Section 6 for details.

4.3 Menu navigation basics

Most of the gauge's various functions and parameters are configured through the main menu. To access the menu press **MENU**. Use the **UP** and **DOWN** keys to scroll through the items. The current selection is denoted with clear text over a dark background. Press **ENTER** to select a menu item, then use **UP** and **DOWN** again to scroll through the sub-menus. Press **ENTER** again to select the sub-menu item.

For parameters that may be either selected or deselected, press **ENTER** to toggle between selecting and deselecting. An asterisk (*) to the left of the parameter label is used to indicate when the parameter has been selected.

For parameters requiring the input of a numerical value, use the **UP** and **DOWN** keys to increment or decrement the value. Press and hold either key to auto-increment at a gradually increasing rate. When the desired value has been reached, press **ENTER** to save the change and revert back to the sub-menu item, or press **ESCAPE** to revert back to the sub-menu item without saving. Press **ESCAPE** to revert one step back in the menu hierarchy until back into normal operating mode.

Refer to the following sections for details about setting up particular functions and parameters.

5 OPERATING MODES

Caution!

In any operating mode, if the capacity of the instrument has been exceeded by more than 110%, the display will show "OVER" to indicate an overload. A continuous audible tone will be sounded (if beeps are enabled) until the MENU key has been pressed or the load has been reduced to a safe level.

Three operating modes are possible with Series 3 gauges. To cycle between the modes, press **MODE** while in the home screen.

5.1 Real time (RT)

The primary reading corresponds to the live measured reading.

5.2 Peak Compression (PC)

The primary reading corresponds to the peak compression reading observed. If the actual force decreases from the peak value, the peak will still be retained in the primary reading area of the display. Pressing **ZERO** will reset the value.

5.3 Peak Tension (PT)

Same as Peak Compression, but for tension readings.

6 CHANGING THE UNITS

Series 3 gauges display one of three measurement units. To change the unit, select **Units** from the menu. The display will appear as follows:

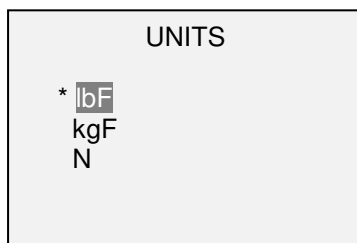

The gauge will always power on with the unit selected.

7 DIGITAL FILTERS

Digital filters are provided to help smooth out the readings in situations where there is mechanical interference in the work area or test sample. These filters utilize the moving average technique in which consecutive readings are pushed through a buffer and the displayed reading is the average of the buffer contents. By varying the length of the buffer, a variable smoothing effect can be achieved. The selection of 1 will disable the filter since the average of a single value is the value itself.

To access digital filter settings, select **Filters** from the menu. The display will appear as follows:

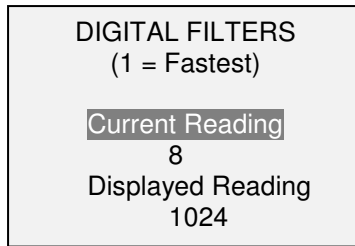

Two filters are available:

Current Reading – Applies to the peak capture rate of the instrument.

Displayed Reading – Applies to the primary reading on the display.

Available settings: 1,2,4,8,16,32,64,128,256,512,1024. It is recommended to keep the current reading filter at its lowest value for best performance, and the displayed reading filter at its highest value for best stability.

8 SET POINT INDICATORS

8.1 General Information

Set points are useful for tolerance checking (pass/fail). Two limits, high and low, are specified and stored in the non-volatile memory of the instrument and the primary reading is compared to these limits.

8.2 Configuration

To configure set points, select **Set Points** from the menu. The screen will appear as follows:

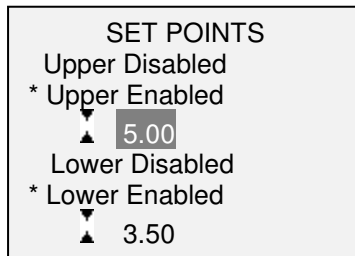

Either one, two, or none of the set points may be enabled. To toggle between the tension and compression directions, press the **DIRECTION** key.

If two set points have been enabled, they are displayed in the upper left corner of the display. If only one set point has been enabled, the word "OFF" will appear in place of the value. If no set points have been enabled, the upper left corner of the display will be blank.

When set points are enabled, the following indicators are shown to the left of the primary reading:

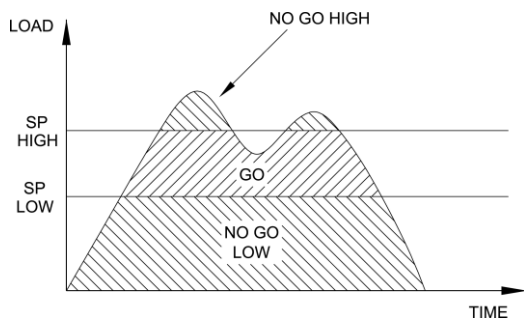

- ▲ – the displayed value is greater than the upper force limit (NO GO HIGH)
- – the displayed value is between the limits (GO)
- ▼ – the displayed value is less than the lower force limit (NO GO LOW)

Note: Set point indicators reference the displayed reading, not necessarily the current live load.

9 COMMUNICATIONS

Communication with Series 3 force gauges is achieved through the micro USB port located along the left side of the housing, as shown in the illustration in the **Power** section. Communication is possible only when the gauge is in the main operating screen (i.e. not in a menu or configuration area). The current reading is transmitted from the gauge when the DATA key is pressed. See Sect. 4.2.

9.1 Installing the USB driver

It is recommended that the USB driver be installed before physically connecting the gauge to the PC with a USB cable.

1. Insert the Resource CD supplied with the gauge into the CD/DVD drive in the computer. Then, navigate in *Windows Explorer* or *My Computer* to one of the following folders on the CD:

Windows 2000 through Vista - "Win_2K_XP_S2K3_Vista"

Windows 7 - "Windows_7"

2. Execute the installer application "Mark-10USBInstaller.exe" by double-clicking it. When the program launches, one of the following windows will appear, depending on the operating system:

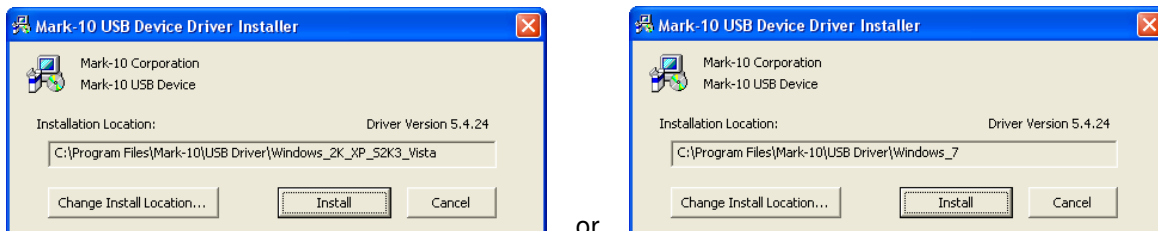

or

Click "Install".

3. The next screen appears as follows:

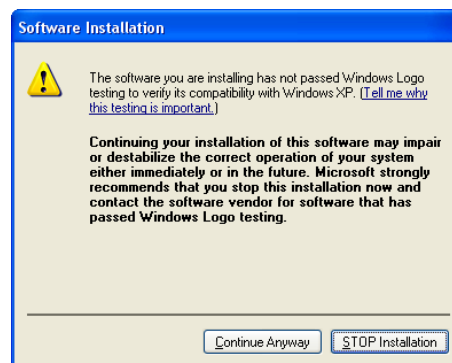

Click "Continue Anyway".

4. After installation completes the following screen may appear in non-Windows 7 operating systems.

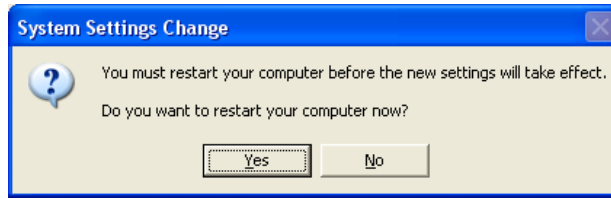

Restart the computer before connecting a Mark-10 USB device.

5. After Windows as restarted, plug in the device. The following will occur:

Windows 7 Operating Systems – When the Mark-10 USB device has been plugged into a USB port, the driver will automatically be found. When the driver installation is complete, a message will appear as follows: “The MARK-10 USB DEVICE driver is now installed and ready to use”.

Non-Windows 7 Operating Systems – When the Mark-10 USB device has been plugged into a USB port, the following screen appears:



Select “No, not this time”, then click “Next”.

6. The next screen appears as follows:

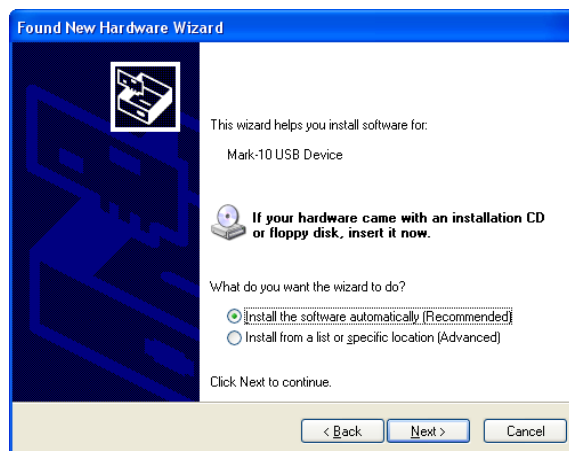

Select “Install the software automatically (Recommended)”, then click “Next”.

7. The next screen appears as follows:

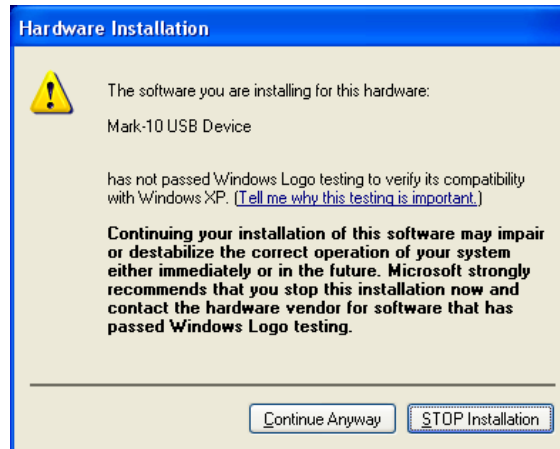

Click "Continue Anyway".

8. The next, and final, screen appears as follows:

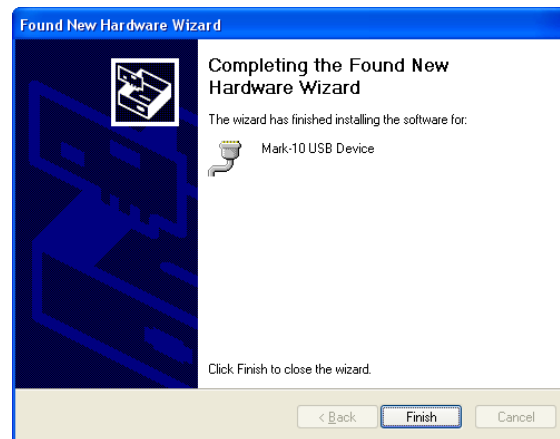

Click "Finish". The Mark-10 USB device is now installed and ready to use. The COM port number assigned by Windows may be identified in Device Manager, or in the communication application being used, such as MESURgauge or HyperTerminal.

9.2 Communication Settings

To set up communication settings, select **USB Settings** from the menu. The screen appears as follows:

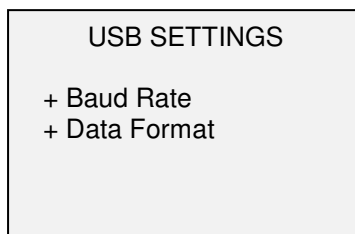

Configure the baud rate and data format as required for the application. Default values are as follows:

Baud Rate: 9,600
Data Format: Numeric + units

Other communication settings are permanently set to the following:

Data Bits: 8
Stop Bits: 1
Parity: None

Individual data points may be transmitted by pressing **DATA**.

10 CALIBRATION

10.1 Initial Physical Setup

The gauge should be mounted vertically to a test stand or fixture rugged enough to withstand a load equal to the full capacity of the instrument. Certified deadweights or master load cells should be used, along with appropriate mounting brackets and fixtures. Caution should be taken while handling such equipment.

10.2 Calibration Procedure

1. Select **Calibration** from the menu. The display will appear as follows:

```
CALIBRATION

To invert the
display, press the
DIRECTION key.

THEN PRESS ENTER
```

2. Press **DIRECTION** to invert the display, if desired. **ENTER** to continue. The display will appear as follows:

```
CALIBRATION
ENTER # CAL POINTS
(1 TO 10)
COMPRESSION:
 5
TENSION :
 5
```

The gauge can be calibrated at up to 10 points in each direction. Enter the number of calibration points for each direction (compression and tension). At least one point must be selected for each direction.

Note: To achieve the accuracy specification of $\pm 0.1\%$, it is recommended to calibrate the gauge at 5 or more even increments in both the tension and compression directions. For example, a gauge with capacity of 10 lbf should be calibrated at 2, 4, 6, 8, and 10 lb loads in each direction.

3. To escape the **Calibration** menu at any time, press **ESCAPE**. The display will appear as follows:

```

CALIBRATION
NOT COMPLETE

CANCEL
EXIT W/O SAVING
  
```

Selecting "CANCEL" will revert back to the Calibration setup. Selecting "EXIT W/O SAVING" will return to the menu without saving changes.

4. After the number of calibration points has been entered, press **ENTER**. The display will appear as follows:

```

CALIBRATION
OFFSET

Place force gauge
horizontal
THEN PRESS ZERO
  
```

5. Place the force gauge horizontally on a level surface free from vibration, then press **ZERO**. The gauge will calculate offsets, and the display will appear as follows:

```

CALIBRATION
OFFSET

Please wait...
  
```

```

CALIBRATION
OFFSET

Sen.Offset Adj.Passed
Ana.Offset Adj.Passed
  
```

If failed:

```

CALIBRATION
OFFSET

Sen.Offset Adj.Failed
Ana.Offset Adj.Failed
  
```

6. The following screen appears after the offsets have been calculated:

```

CALIBRATION
COMPRESSION

Attach necessary
weight fixtures.

THEN PRESS ENTER
  
```

Attach weight fixtures (brackets, hooks, etc), as required. Do not yet attach any weights or apply any calibration loads. Then press **ENTER**.

7. The display will appear as follows:

```
CALIBRATION
COMPRESSION

Optionally exercise
load cell a few times.

THEN PRESS ENTER
```

Optionally exercise the load cell shaft several times (at full scale, if possible), then press **ENTER**.

8. The display will appear as follows:

```
CALIBRATION
COMPRESSION
GAIN ADJUST
APPLY FULL SCALE LOAD
10.000 LBF +/-20%
THEN PRESS ENTER
```

Apply a weight equal to the full scale of the instrument, and then press **ENTER**.

9. After displaying "PLEASE WAIT..." the display will appear as follows:

```
CALIBRATION
COMPRESSION

ENSURE NO LOAD

THEN PRESS ZERO
```

Remove the load applied in Step 8, leave the fixtures in place, then press **ZERO**.

10. The display will appear as follows:

```
CALIBRATION
COMPRESSION
APPLY LOAD
1 OF 5
ENTER LOAD:
2.000 LBF
THEN PRESS ENTER
```

Use the **UP** and **DOWN** keys to adjust the load value as required. The load values default to even increments, as indicated by the previously entered number of data points (even increments are recommended for best results). For example, if a 50 lbF capacity gauge is calibrated, and 5 data points were selected, the load values will default to 10, 20, 30, 40, and 50 lb. Apply the calibration load. Then press **ENTER**.

Repeat the above step for the number of data points selected.

11. After all the compression calibration points have been completed, the display will appear as follows:

CALIBRATION
COMPRESSION COMPLETE
REVERSE DIRECTION
FOR TENSION
Attach necessary
weight fixtures.
THEN PRESS ENTER

Press **ENTER**.

12. The display will appear as follows:

CALIBRATION

To invert the
display, press the
DIRECTION key.

THEN PRESS ENTER

Reverse the orientation of the load cell shaft by rotating the gauge 180 degrees. Press **DIRECTION** to invert the display. Then attach weight fixtures. The following screens will step through the same procedure as with the compression direction. Proceed in the same manner.

13. At the completion of the tension calibration, the display will appear as follows:

CALIBRATION
COMPLETE

SAVE & EXIT
EXIT W/O SAVING

To save the calibration information, select "SAVE & EXIT". To exit without saving the data select "EXIT W/O SAVING".

14. Any errors are reported by the following screens:

CALIBRATION

Units must be gF.

PLEASE TRY AGAIN
PRESS ENTER

Displayed at the start of calibration if a disallowed unit is selected.

LOAD NOT STABLE
PLEASE TRY AGAIN

Ensure that the load is not swinging, oscillating, or vibrating in any manner. Then try again.

CALIBRATION
COMPRESSION

LOAD TOO LOW

PLEASE TRY AGAIN

The calibration weight does not match the set value.

CALIBRATION
TENSION

LOAD TOO CLOSE
TO PREVIOUS
PLEASE TRY AGAIN

The entered calibration point is too close to the previous point.

11 OTHER SETTINGS

11.1 Automatic Shutoff

The gauge may be configured to automatically power off following a period of inactivity while on battery power. Inactivity is defined as the absence of any key presses or load changes of 100 counts or less. To access these settings, select **Automatic Shutoff** from the menu. The display will appear as follows:

AUTOMATIC SHUTOFF

* Disabled
Enabled
Set Minutes
5

Select **Disabled** to disable automatic shutoff. Select **Enabled** to enable it. The length of time of inactivity is programmed in minutes via the **Set Minutes** parameter. Available settings: 5-30, in 5 minute increments.

Note: If the AC adapter is plugged in, the gauge will ignore these settings and remain powered on until the **POWER** key is pressed.

11.2 Backlight

Several initial settings are available, upon powering on the gauge. To access these settings, select **Backlight** from the menu. The display will appear as follows:



Select **Off** for the backlight to be off upon powering on the gauge.

Select **On** for the backlight to be on upon powering on the gauge.

Select **Auto** for the backlight to be on upon powering gauge, but will shut off after a period of inactivity (as defined in the **Automatic Shutoff** sub-section). The backlight will turn on again when activity resumes. The length of time of inactivity is programmed in minutes via the **Set Minutes** parameter. Available settings: 1-10, in 1 minute increments.

Note: If the AC adapter is plugged in, the gauge will ignore these settings and keep the backlight on. Selecting the **On** or **Off** setting in the **Backlight** menu will manually turn the backlight on or off as if the Backlight key were pressed.

11.3 LCD Contrast

The contrast of the display may be adjusted. Select **LCD Contrast** from the menu. The screen will appear as follows:



Press **ENTER** to modify the contrast. Select a value from 0 to 25, 25 producing the most contrast.

11.4 Beeps

Audible tones can be enabled for all key presses and alerts, such as overload, set point value reached, etc. The Set Point alert can be configured to be either a momentary tone or a continuous tone (until the load is restored to a value between the set points). To configure the functions for which audible tones will apply, select **Beeps** from the menu. The screen will appear as follows:

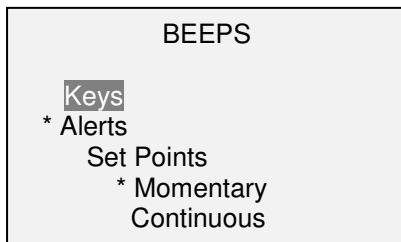

11.5 Initial Mode

This section is used to configure the initial mode upon powering on the gauge. To access this parameter, select **Initial Mode** from the menu. The screen will appear as follows:

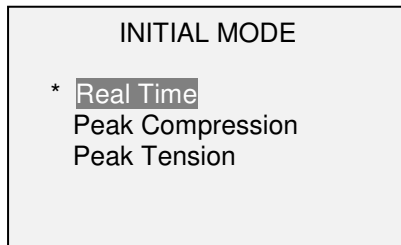

The default value is Real Time.

11.6 Information / Welcome Screen

The following screen is displayed at power up and can be accessed at any time by selecting **Information** from the menu:

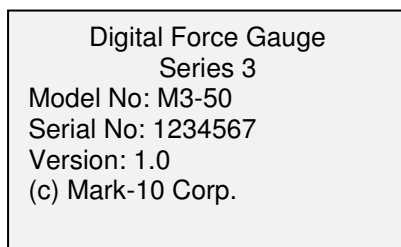

12 SPECIFICATIONS

12.1 General

Accuracy:	±0.3% of full scale ±1 digit
Sampling rate:	2,000 Hz
Power:	AC or rechargeable battery. Low battery indicator appears when battery level is low, and gauge powers off automatically when power reaches critical stage.
Battery life:	Backlight on: up to 7 hours of continuous use Backlight off: up to 24 hours of continuous use
Measurement units:	lbF, gF, kgF, N (depending on model)
USB output:	Fully configurable up to 115,200 baud
Configurable settings:	Digital filters, USB output, set points, automatic shutoff, default units, default mode, key tones, audio alarms, calibration
Safe overload:	150% of full scale (display shows "OVER" at 110% and above)
Weight (gauge only):	M3-012 – M3-100: 0.7 lb [0.33 kg] M3-200 – M3-500: 0.9 lb [0.41 kg]
Included accessories:	Carrying case, chisel, cone, V-groove, hook, flat, extension rod, AC adapter, battery, USB cable, resource CD (USB driver, MESUR Lite software, MESURgauge DEMO software, and user's guide), NIST-traceable certificate of calibration with data
Warranty:	3 years (see individual statement for further details)

12.2 Factory Settings

Parameter	Setting
Set points	
Upper	Disabled (defaults to 80% of full scale, compression, when enabled)
Lower	Disabled (defaults to 40% of full scale, compression, when enabled)
Filters	
Current	8
Displayed	1024
Backlight	Auto
Minutes	1
USB Output	
Baud Rate	9,600
Data Format	Numeric + units
Automatic Shutoff	Enabled
Minutes	5
Beeps	
Keys	Enabled
Alerts	Enabled
Set Points	Momentary
LCD Contrast	10
Initial Mode	Real Time
Units	lbF

12.3 Capacity, Resolution & Load Cell Deflection

Model	Capacity				Resolution				Load Cell Deflection in [mm]
	lbF	kgF	gF	N	lbF	kgF	gF	N	
M3-012	0.12		50	0.5	0.0001		0.05	0.0005	0.005 [0.13]
M3-025	0.25		100	1	0.0002		0.1	0.001	0.010 [0.25]
M3-05	0.5		250	2.5	0.0005		0.2	0.002	0.010 [0.25]
M3-2	2	1		10	0.002	0.001		0.01	0.010 [0.25]
M3-5	5	2.5		25	0.005	0.002		0.02	0.010 [0.25]
M3-10	10	5		50	0.01	0.005		0.05	0.010 [0.25]
M3-20	20	10		100	0.02	0.01		0.1	0.010 [0.25]
M3-50	50	25		250	0.05	0.02		0.2	0.010 [0.25]
M3-100	100	50		500	0.1	0.05		0.5	0.010 [0.25]
M3-200	200	100		1000	0.2	0.1		1	0.010 [0.25]
M3-500	500	250		2500	0.5	0.2		2	0.010 [0.25]

12.4 Dimensions
IN [MM]

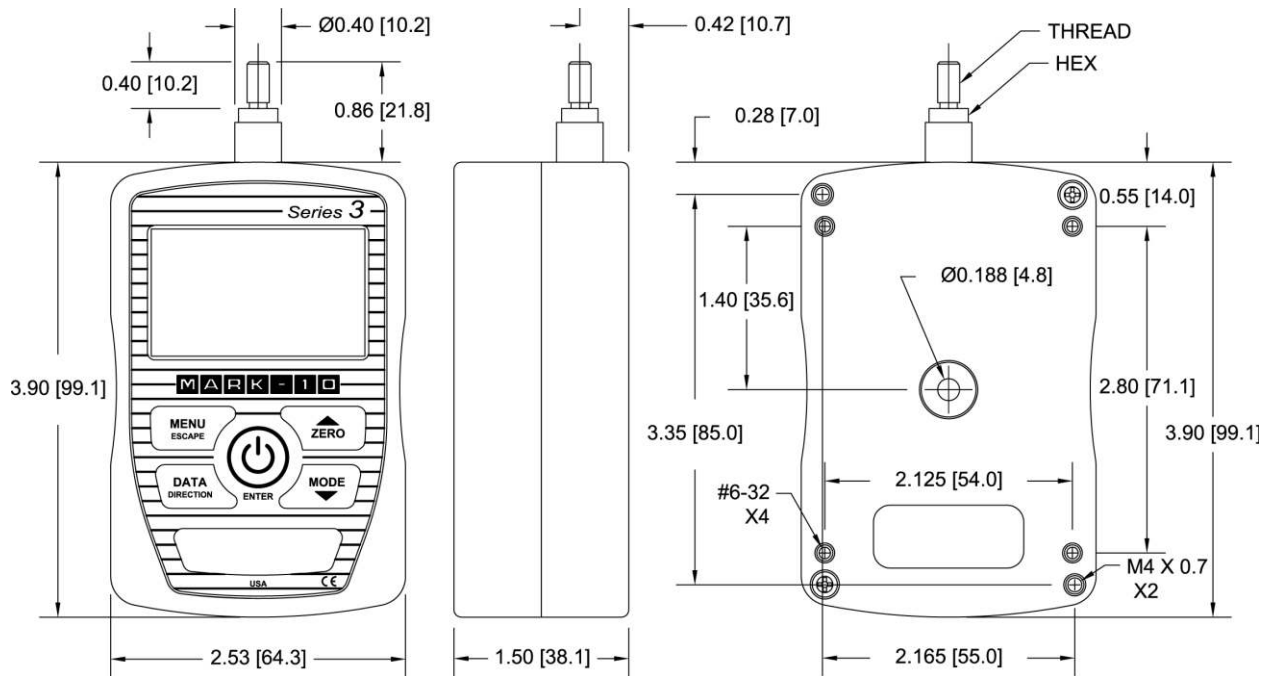

	Thread	Hex
M3-012 – M3-100	#10-32 UNF	5/16 [7.94]
M3-200 – M3-500	5/16-18 UNC	11/32 [8.74]

NOTES: