

14.0 WARRANTY

ELECTROMATIC Equipment Co., Inc. (ELECTROMATIC) warrants to the original purchaser that this product is of merchantable quality and confirms in kind and quality with the descriptions and specifications thereof. Product failure or malfunction arising out of any defect in workmanship or material in the product existing at the time of delivery thereof which manifests itself within five years from the sale of such product, shall be remedied by repair or replacement of such product, at ELECTROMATIC’s option, except where unauthorized repair, disassembly, tampering, abuse or misapplication has taken place, as determined by ELECTROMATIC. All returns for warranty or non-warranty repairs and/or replacement must be authorized by ELECTROMATIC, in advance, with all repacking and shipping expenses to the address below to be borne by the purchaser.

THE FOREGOING WARRANTY IS IN LIEU OF ALL OTHER WARRANTIES, EXPRESSED OR IMPLIED, INCLUDING BUT NOT LIMITED TO, THE WARRANTY OF MERCHANTABILITY AND FITNESS FOR ANY PARTICULAR PURPOSE OR APPLICATION. ELECTROMATIC SHALL NOT BE RESPONSIBLE NOR LIABLE FOR ANY CONSEQUENTIAL DAMAGE, OF ANY KIND OR NATURE, RESULTING FROM THE USE OF SUPPLIED EQUIPMENT, WHETHER SUCH DAMAGE OCCURS OR IS DISCOVERED BEFORE, UPON OR AFTER REPLACEMENT OR REPAIR, AND WHETHER OR NOT SUCH DAMAGE IS CAUSED BY MANUFACTURER’S OR SUPPLIER’S NEGLIGENCE WITHIN FIVE YEARS FROM INVOICE DATE.

Some State jurisdictions or States do not allow the exclusion or limitation of incidental or consequential damages, so the above limitation may not apply to you. The duration of any implied warranty, including, without limitation, fitness for any particular purpose and merchantability with respect to this product, is limited to the duration of the foregoing warranty. Some states do not allow limitations on how long an implied warranty lasts but, notwithstanding, this warranty, in the absence of such limitations, shall extend for five years from the date of invoice.

ELECTROMATIC Equipment Co., Inc.
600 Oakland Ave. Cedarhurst, NY 11516—USA
Tel: 1-800-645-4330/ Tel: 516-295-4300/ Fax: 516-295-4399

Every precaution has been taken in the preparation of this manual. Electromatic Equipment Co., Inc., assumes no responsibility for errors or omissions. Neither is any liability assumed for damages resulting from the use of information contained herein. Any brand or product names mentioned herein are used for identification purposes only, and are trademarks or registered trademarks of their respective holders.

Table of Contents

1.0 Introduction	2
1.1 Applications	
2.0 Safety Precautions	3
3.0 Contents of Complete Outfit	4
4.0 Overview of YSL-2000HD	5
4.1 LCD Display	
4.2 Front Panel Key Functions	
5.0 Installing Batteries	6
6.0 Measuring Yarn/Wire Speed & Length	7
7.0 Measuring Surface Speed or Length	9
8.0 Using Optional Surface Speed Wheels	10
9.0 Measuring RPM	11
9.1 Contact Operation	
9.2 Non-Contact Operation	
10.0 Memory System	13
11.0 Specifications	14
12.0 Spare Parts & Optional Accessories	15
13.0 Removing the Protective Rubber Shell	15
14.0 Warranty	16

1.0 INTRODUCTION

The CHECK•LINE® YSL-2000HD is supplied with two (2) special -purpose measuring heads which converts it into any of three separate instruments detailed below. The units of measure are user-selected and shown on the LCD Display along with the measured value.

Yarn/Wire Speed & Length Meter

With the *Yarn/Wire Speed & Length Meter* Measuring Head installed, the YSL-2000HD accurately measures the speed and lengths of yarns, wires and similar filaments. The measure head is composed of a precision, low-inertial measuring wheel and a “wrapper” roller. The “wrapper” roller directs the filament over the measuring wheel to maximize surface contact. This helps to eliminate filament slip and breakage, especially when measuring fragile yarns, fibers and fine wires.

Contact Tachometer

With the *Contact Tachometer* Measuring Head installed, the YSL-2000HD can be used to measure the rotational speed of rotating motors, shafts, pulley, gear, etc., using the cone or funnel tip adapter. In applications where surface speeds (conveyor belts, printed materials, webs of paper or fabric, etc.) are to be measured, the universal wheel is used for direct readout in feet/min, meters/min or inches/min, as selected by the user. It can also be used to measure the accumulated total of continuously running material, such as paper, wire/yarn being wound on a spool or for checking the calibration of on-line counters and totalizer devices.

Non-Contact Tachometer

Without either Measuring Head installed, the YSL-2000HD can be used as a Non-Contact Tachometer. In this operating mode, a small piece of reflective tape is applied to the rotating element (wheel, shaft, etc.). It uses a visible LED light source to accurately measure the RMP for up to 14" (350 mm) away from the “target.”

12.0 SPARE PARTS & OPTIONAL ACCESSORIES

Standard Spare Parts

CDT-ADAP	Slide-In Contact Adapter
DTCA	Cone Tip Adapter
DT6	6" (152mm) Circumference Surface Speed Wheel
DT-TAPE	10 Strips of Reflective Tape - 1/2" x 4" (12 x 100mm)

Optional Accessories

DTFA	Funnel Tip Adapter
DTSX	Shaft Extension
CDT-WHEEL	0.1 meter Circumference Surface Speed Wheel
DT12	12" Circumference Surface Speed Wheel

13.0 REMOVING PROTECTIVE RUBBER SHELL

The gauge is supplied with a durable rubber shell that provides an added measure of physical and environmental protection in harsh applications.

To remove the shell, follow the procedure outlined below:

1. Using your thumbs, slide the rubber shell up and off of one corner of the gauge. Repeat for the other corner.
2. Pull the shell down until it is completely off the corners of the gauge, then pull the gauge forward and out of the shell.
3. Replace the shell by sliding the gauge bottom first into the large center opening, then, one at a time, slip the corners of the shell back over the gauge.



11.0 SPECIFICATIONS

Measuring Ranges – rpm			
Optical	1 – 99,999 rpm		
Mechanical	1 – 99,999 rpm		
Measuring Ranges – speed			
Wheel Size	6"	12"	0.1 m
<i>m/min</i>	0.10–1524	0.40–609.6	0.10–1999
<i>ft/min</i>	0.40–5000	0.40–2000	0.40–6550
<i>in/min</i>	4.0–60.00	4.00–24.000	4.00–78.700
<i>m/sec</i>	0.10–25.40	0.10–10.16	0.10–33.30
<i>ft/sec</i>	0.10–83.33	0.10–33.33	0.10–109
Measuring Ranges – length			
	0 – 99,999 m, / 0 – 99,999 ft / 0 – 99,999 in		

Other Specifications	
Resolution	.01 from 0 – 100 .1 from 100 – 1,000 1 from 1000 – 99,999
Accuracy	±0.02% of reading or ±1 digit
Display	5-Digit LCD, 10mm high
Decimal Point	Automatic
Memory System	Maximum, minimum, average and last reading (retained in memory for the life of batteries)
Measurement System	
<i>Non-Contact</i>	Visible LED light beam
<i>Contact</i>	Contact adapter
Engineering units	
<i>RPM</i>	RPM
<i>Surface Speed</i>	Feet/min, inches/min and meters/min
<i>Length</i>	Feet, inches, meters
Sensing Distance	Up to 24 inches (60 cm)
Display Update Time	0.5 seconds or one measuring period
Auto Power Off	After 30 seconds of non-use (minimum, maximum average, and last reading retained in memory)
Battery Life	40 hours continuous use (approx.) with alkaline batteries
Battery Type	2 AA (1.5 V) or rechargeable
Weight	6 ounces (170 grams)
Housing Material	ABS Plastic
Operating Temperature	32 to 122° F (0 to 50° C)
Storage Temperature	– 4 to 158° F (–20 to 70° C)
Accessories Included	Contact adapter, cone tip, 6" circumference universal surface speed wheel, reflective tape, NIST-traceable calibration certificate, operating instructions and foam-fitted, hard-plastic carrying case

2.0 SAFETY PRECAUTIONS

All operators should wear safety goggles when using this or any other tachometer. Failure to do so could result in serious injury!

1. Check condition of housing, slide-on Contact Adapter and split mounting hubs of push-in Contact Cone, Surface Speed Wheel and any other accessories. Replace those that are worn, loose-fitting or cracked. The Contact Adapter shaft should rotate freely.
2. When operating in the contact mode, be sure Contact Adapter fits snugly into the housing grooves.
3. When using the Surface Speed Wheel accessory, make sure it fits the tachometer shaft snugly. In operation, keep the wheel perpendicular and parallel to the moving surface to prevent it from running off the tachometer shaft.
4. Do not use the standard surface speed wheel for speeds in excess of 1000 feet per minute. For higher speeds, specify the optional Heavy-Duty Surface Speed Wheel (DT12) with set-screw mounting.
5. Store the instrument in its carrying case when it is not in use

3.0 CONTENTS OF COMPLETE OUTFIT

The YSL-2000HD is supplied with the following accessories in a foam-fitted, carrying case:

1. Slide-on Measuring Head for Yarn/Wire Speed & Length
2. Slide-On Measuring Head for Contact Tachometer Operation
3. Surface Speed Wheel
4. Cone Tip Measuring Adapter
5. Shaft Extension
6. Reflective Tape
7. Two (2) AA Batteries

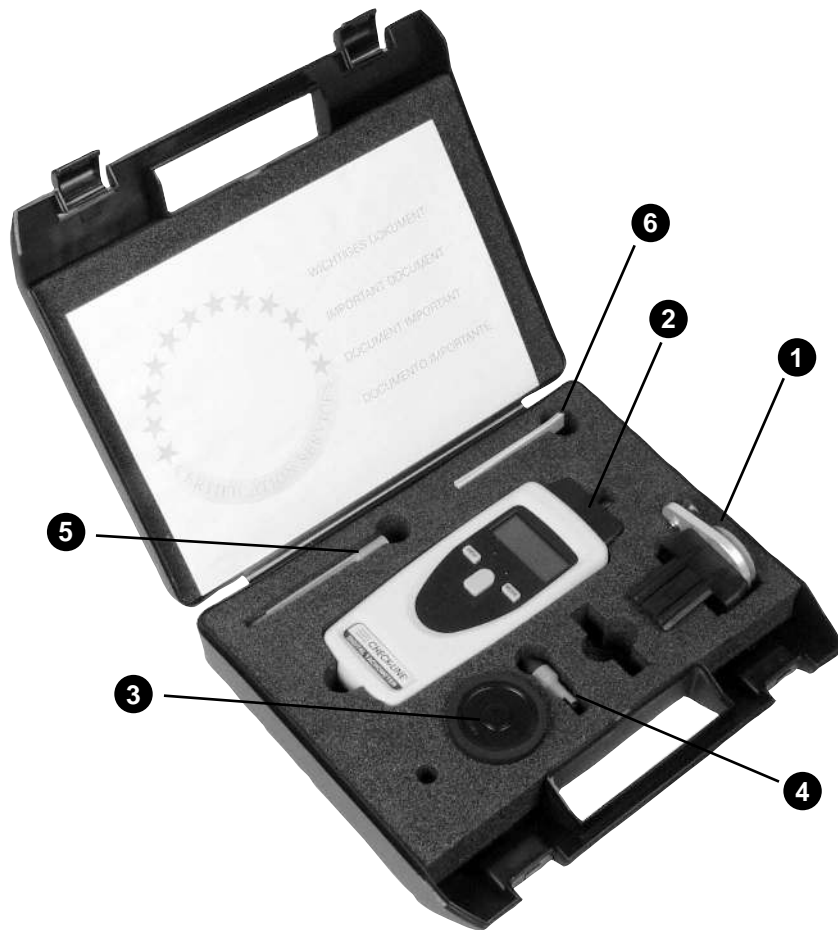

10.0 MEMORY SYSTEM

The YSL-2000HD is supplied with a built-in memory system which stores the *last* measurement, *maximum* measurement, *minimum* measurement, and the *average* measurement which occurred during a measuring period.

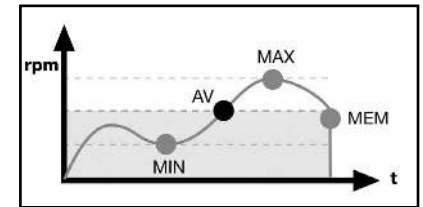

A measuring period is the interval of time while the Measure key is depressed. The stored values are retained in memory even when the power turns off (auto power off). To recall the stored values after auto power off:

1. Press the Measure key to turn the power on
2. Press the MEM key to recall the desired value

MEM The Memory key accesses the YSL-2000HD's built-in memory. Each time the MEM key is pressed the values stored in memory will be recalled to the display in the sequence listed below. The appropriate memory indicator will be shown together with the recalled value on the display.

Note: When the batteries are removed, the values stored in memory will be lost.

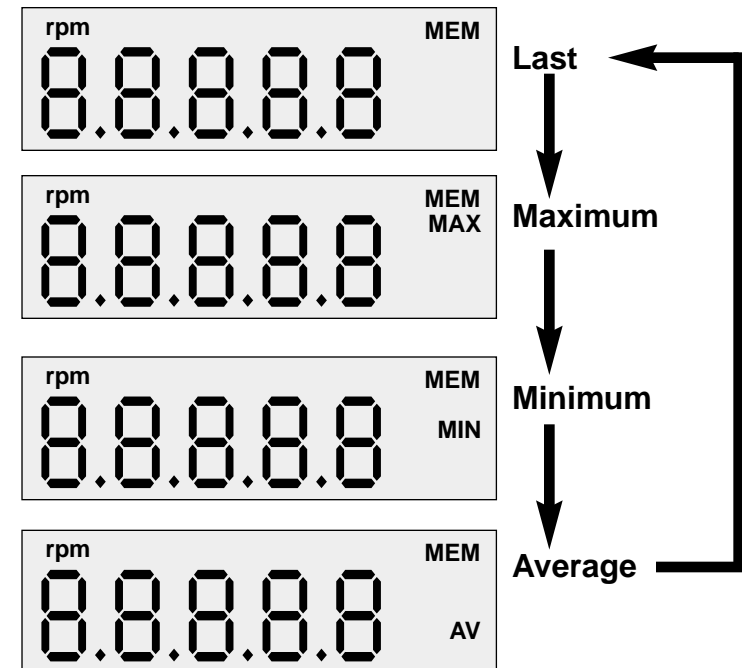

9.2 Non-Contact Operation - RPM

1. Remove the Contact Adapter.
2. Attach a small piece of the supplied reflective tape to the rotating element (shaft, pulley, etc.).
3. Select the Non-Contact RPM mode by pressing the MODE key until the rpm symbol appears in the top left corner of the LCD display
4. Aim the YSL-2000HD at the target using the red visible light beam for alignment assistance.
5. Press and hold the MEASURE key to begin taking measurements. The On-Target™ indicator will be displayed on the LCD if the instrument is properly aimed at the target (reflective tape).
6. Release the Measure key prior to removing the instrument from the target. The last reading will be retained on the LCD display.

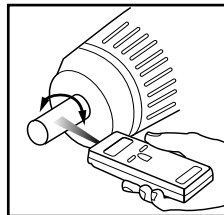
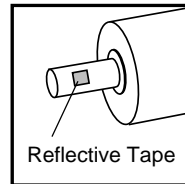
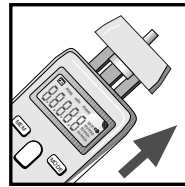

Hints for Non-Contact Measurements

1. The non-reflective area should be larger than the reflective area.
2. If the rotating element is highly reflective, cover it with black tape or paint to improve the contrast between the reflective tape and the surface of the rotating element.

4.0 OVERVIEW OF YSL-2000HD

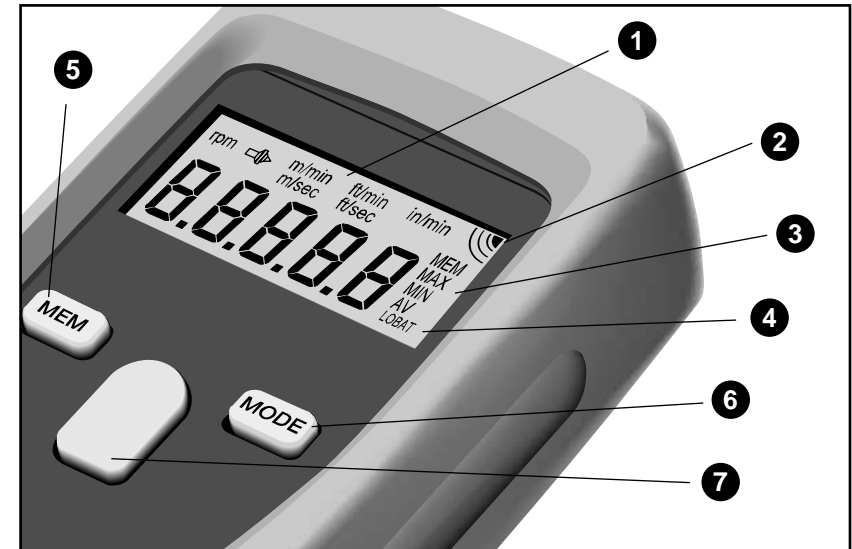

4.1 LCD Display

1. *Units of Measure Indicators*—Indicates which unit of measure is being shown on the display.
2. *On-Target Indicator* — Flashes to indicate that the unit is lined up correctly for an accurate non-contact measurement.
3. *Memory Indicators* — Indicates which type of measurement stored in memory (last, max., min., avg) is being displayed.
4. *Low Battery Indicator* — Indicates that batteries need replacement.

4.2 Front Panel Key Functions

5. MEM: Access the memory. Each time the key is pressed the values stored in memory will be recalled to the display.
6. MODE: Each time the MODE key is pressed, the units of measure will change.
7. MEASURE: The MEASURE Key performs the following functions:
 - Turns on the power
 - Starts and stops the measuring period
 - Exits from the memory mode
 - Selects the displayed wheel type when using one of the optional surface speed wheels.

5.0 INSTALLING BATTERIES

1. Turn the gauge over and locate the battery compartment. You do not have to remove the rubber shell.



2. Open the battery compartment by pulling down on the tab located at the top of the battery cover and remove the cover. Insert two AA batteries following the orientation engraved on the inside of the battery compartment.

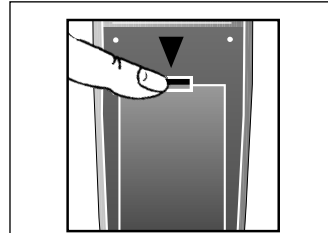

3. Replace the battery cover by inserting the two tabs located on the bottom edge of the cover into the matching slots in the housing.

4. Push the cover closed until the tab at the top of the battery cover “clicks” into a locked position.

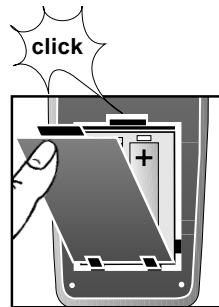

5. Replace the cut-out section of the protective rubber shell.

9.0 MEASURING RPM

9.1 Contact Operation - RPM

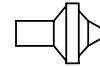

1. Install the Slide-on Contact Adapter. Push on securely
2. Slide the Cone Tip adapter over the shaft of the instrument. Be sure to align the pin on the side of the shaft with the slot in the adapter. Push on securely.

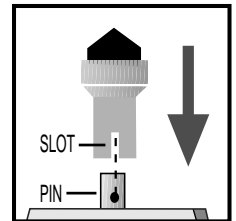
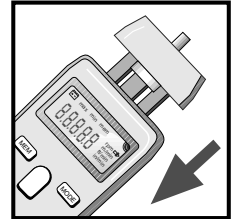

3. Select the Contact RPM mode by pressing the MODE key until the rpm symbol appears in the top left corner of the LCD display

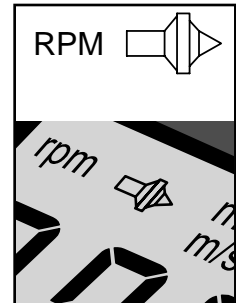

4. Position the adapter carefully so that it contacts the center of the rotating shaft. Apply enough pressure to eliminate any slip.
5. Press and hold the MEASURE key to take measurements.
6. Release the MEASURE key prior to removing the instrument from the rotating element. The LAST reading will be retained on the display.

8.0 USING OPTIONAL-SIZED SURFACE SPEED WHEELS

The following wheels can be used with the YSL-2000HD

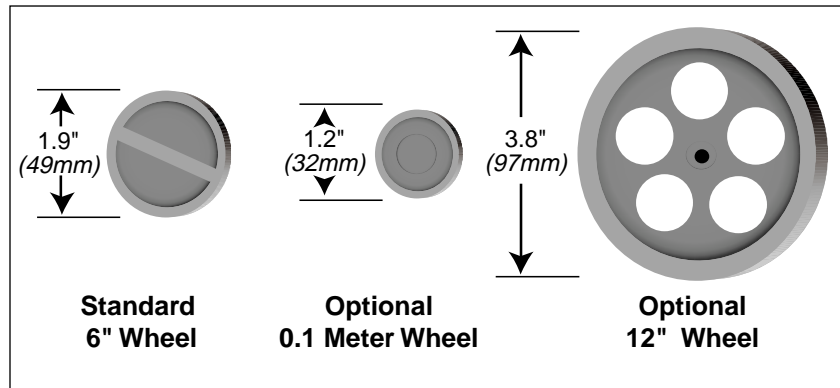

8.1 Setting Wheel Size

1. Press MEM and MODE keys simultaneously & release. The currently selected wheel size will show in the display
2. Change this setting to match the wheel being used by pressing the MODE key. Each time the MODE key is pressed, the wheel type will change as follows:
6" → 0.1 → 12" and repeat
3. When the correct size is shown on the display, press the MEASURE key to select.

NOTE: Factory default setting for wheel type is 6". If wheel type is changed, the new setting is retained in memory. When batteries are changed, wheel type setting will revert to factory default.

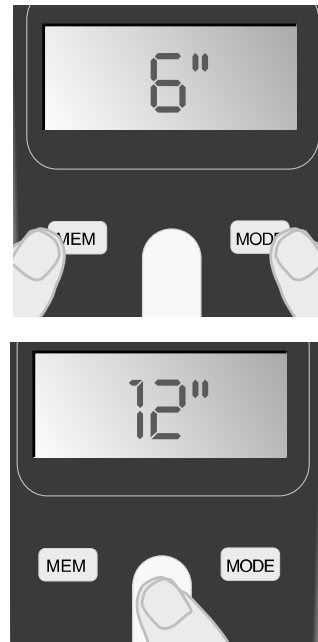

6.0 MEASURING YARN/WIRE SPEED & LENGTH

1. Install the Slide-on Measuring Head for Yarn/Wire Speed & Length.

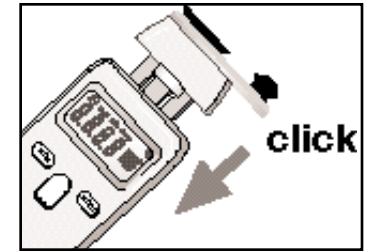

2. Select the desired units of measure for speed or length by pressing the MODE key until the appropriate symbol is shown on the LCD display.

Speed	Length
feet/min	feet
meters/min	meters
inches/min	inches

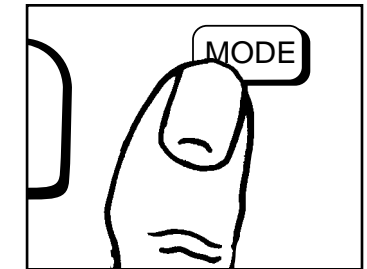

3. Press MEM and MODE keys simultaneously & release. The currently selected wheel size will show in the display. Refer to fig. A.
4. Change this setting to 0.1 to match the wheel being used for measuring yarn rate/speed by pressing the MODE key. Each time the MODE key is pressed, the wheel type will change as follows:
6" → 0.1 → 12" and repeat
5. When 0.1 is shown on the display, press the MEASURE key to select. Refer to fig. B.

NOTE: Factory default setting for wheel type is 6". If the wheel type is changed, the new setting is retained in memory. **When batteries are changed, wheel type setting will revert to factory default.**

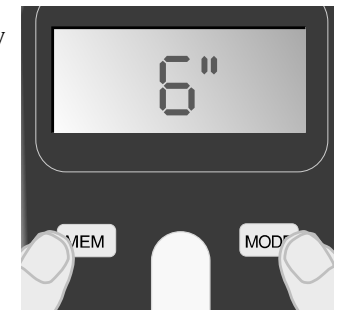

A

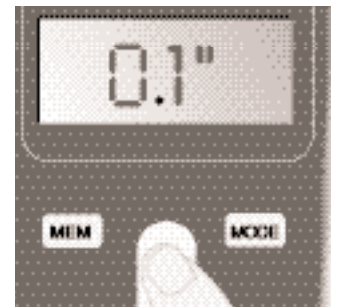

B

6. Insert the filament between the outer “wrapper” roller and measuring wheel letting it contact the flat surface on the top of the Wrapper Roller Arm. Rotate the instrument counter-clockwise approximately 90 degrees (1/4 turn). The filament should run through the groove of both rollers. Keep the instrument steady, avoiding any disturbance of the filament path.

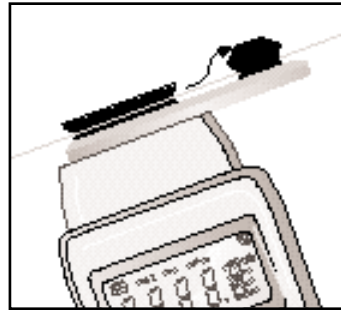

7. Press and hold the Measure key to take measurements.
 8. Release the Measure key prior to removing the instrument from the moving filament. The last reading will be retained on the display.
- Refer to Memory System Section 10.0 for details on using the built-in memory.

7.0 MEASURING SURFACE SPEED OR LENGTH

1. Install the Slide-on Contact Adapter.

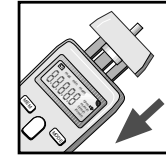

2. Slide the Surface Speed Wheel over the shaft of the instrument. Be sure to align the pin on the side of the shaft with the slot in the adapter. Push on securely.

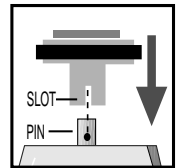

NOTE: If using optional surface speed wheel, refer to Section 8.0 before continuing.

3. Select the desired units of measure for surface speed or length by pressing the MODE key until the appropriate symbol appears on the LCD Display.

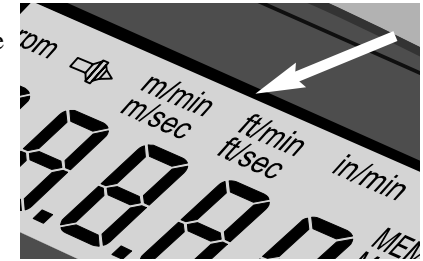

The units of measure appear in the following sequence:

RPM → m/min → m/sec → ft/min → ft/sec → in/min → m → ft → in

4. Position the wheel carefully so that it is perpendicular to the moving surface. Apply enough pressure to eliminate any slip.
5. **Press and hold** the MEASURE key to take measurements.

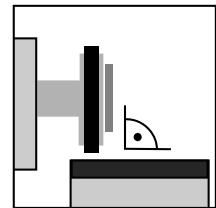

6. Release the MEASURE key prior to removing the instrument from the moving surface. The Last reading will be retained on the display.

YSL-2000HD Digital Tachometer



ELECTROMATIC
EQUIPMENT CO., INC.
600 Oakland Ave., Cedarhurst, NY 11516-U.S.A.
TEL: 516-295-4300 • FAX: 516-295-4399