



## 2 YEAR WARRANTY (RESTRICTIONS APPLY)

Imada, Inc. warrants its products to the original purchaser to be free from defects in workmanship and material under normal use and proper maintenance for two years (one year for adapters, attachments and cables) from original purchase. This warranty shall not be effective if the product has been subject to overload, shock load, misuse, negligence, accident or repairs attempted by others than Imada, Inc.

During the warranty period, we will, at our option, either repair or replace defective products. Please call our customer service department for a return authorization number and return the defective product to us with freight prepaid.

The foregoing warranty constitutes the SOLE AND EXCLUSIVE WARRANTY, and we hereby disclaim all other warranties, express, statutory or implied, applicable to the products and/or software, including but not limited to all implied warranties of merchantability, fitness, non-infringement, results, accuracy, security and freedom from computer virus. In no event shall Imada, Inc. and/or its affiliated companies be liable for any incidental, consequential or punitive damages in connection with the use of its products and/or software.



**Complete color  
catalog available.  
Call 800-373-9989  
or E-mail us.**

3100 Dundee Rd., Suite 707, Northbrook, IL 60062 USA

Telephone: (847) 562-0834 Fax: (847) 562-0839

www.imada.com E-mail: imada@imada.com

ISO 9001 & ISO/IEC 17025 Accredited

04/07

*Specifications subject to change without notice.*

# Digital Force Gauge

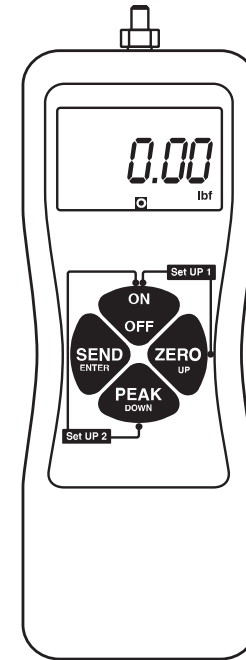

**Model: DS2**

# INSTRUCTION MANUAL

## INTRODUCTION

DS2 Series are state-of-the-art basic performance, easy-to-use digital force gauges which feature giant, easy-to-read LCD displays and provide RS-232, Digimatic and analog output. The Real time measuring mode displays force transients and the Peak measuring mode captures the peak force achieved during a test. Selectable lbf(ozf), kgf(gf), and N measuring units.

## IMPORTANT

*Make sure to read this manual before operating.*

- WARNING!!** Test samples and fixtures can break or shatter, wear eye and body protection to avoid injury.
- WARNING!!** REGARDLESS of whether the unit is ON or OFF, **DO NOT** exceed the capacity of the gauge. At 110% of the rated capacity, the display flashes to warn. **NEVER** exceed 200% of the rated capacity, or the load cell will be damaged. Avoid shock load.
- The gauge can be used between 30 - 100°F (0 - 40°C) For the most accurate results, use the gauge at temperatures close to ones on the certificate of calibration.
- When mounting DS2 Series, use M4 mounting screws with a maximum insertion depth of 8 mm into the gauge.
- Measure in line tension and compression forces only. **DO NOT** attempt to measure forces at an angle to the measuring shaft - damage to load cell and/or shaft may result.
- Hand tighten attachments. **DO NOT** use tools.
- Make sure this gauge and all peripherals are powered down before attaching any cables.
- DO NOT** disassemble the gauge. Disassembly voids warranty.
- Use only Imada AD120 (or AD230) charger/adapter.

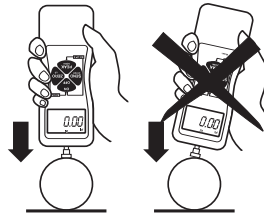

## Optional Adapter Plate

AP-001 Adapter Plate mounts

DS2 gauges to most other brands of test stands.

Use the 4 screws (included) to mount the DS2 gauge to the AP-001 adapter plate. Then use the 2 PEM nuts on the AP-001 adapter plate to mount to other brands of test stand.

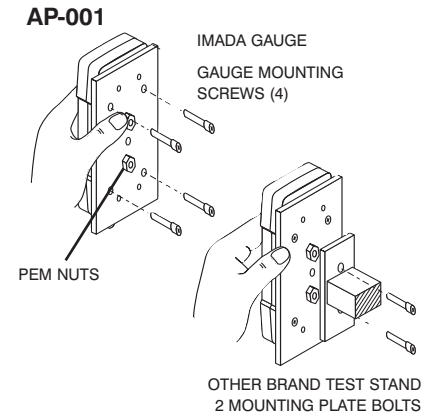

## DS2 DIMENSIONS

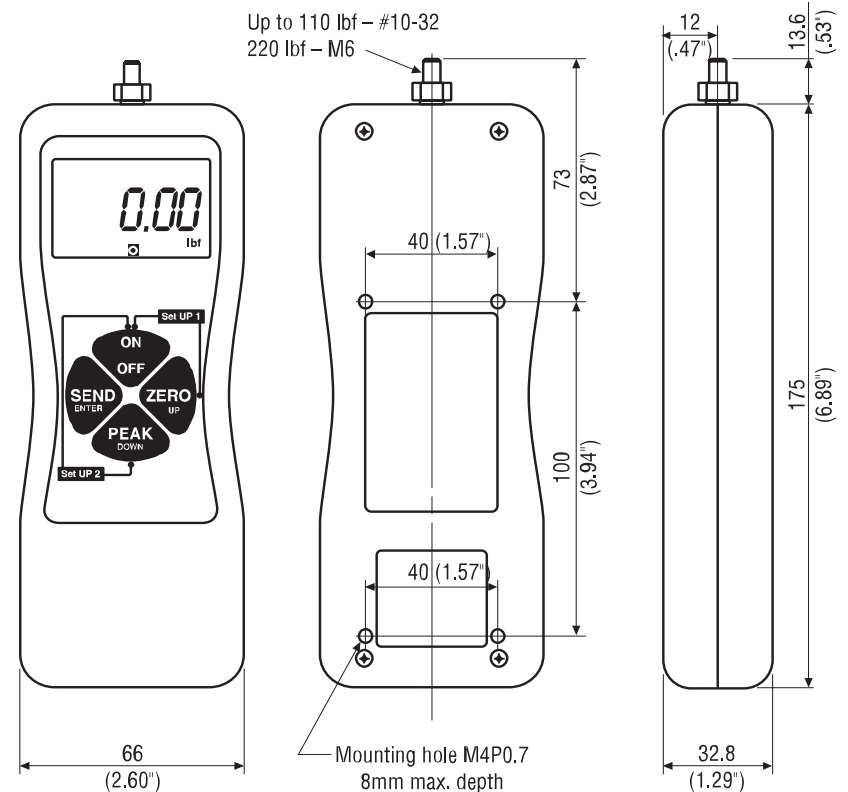

## RECHARGING NI-MH BATTERY

1. To maximize the life of the battery, power is shut off after 10 minutes of non-use. Automatic shut off is bypassed when used with the AC adapter/charger.
2. Battery icon will flash when the gauge needs to be recharged.
3. Turn off power. Only use the IMADA AC adapter/charger provided, AD120 for 115VAC, AD230 for 230VAC. Plug into the correct AC output. It takes 10 hours to charge fully.
4. When the gauge is turned off, make sure the AC adapter/charger is disconnected to avoid overcharging.

## ACCESSORIES

### Optional Handle

The OH-1 optional handle fits DS2 gauges. Constructed of high quality steel for rugged use, the handle facilitates measurements of heavy loads. Complete with mounting screws.

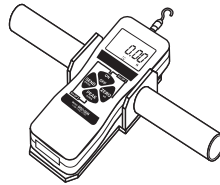

### Optional SW-1 Data Acquisition Software

Use SW-1 software to capture and analyze peak data from DS-2 force gauges. A running log of all the data is displayed along with a chart. Calculate max/min, average, and standard deviation.

### Optional Cables

**CB-101** Analog cable (10')



**CB-203** RS-232C cable (10', 9 pin female)



**CB-301** Digimatic Cable (10')



### Measuring Shaft

Attach any of the included standard attachments or optional special attachments to measure tension or compression forces.  
up to 110 lbf- #10-32  
220 lbf- M6

### Send

Transmit display value

### Charger Port

Recharge the internal NiMH battery or use the Imada AD120 or AD230 adapters only.

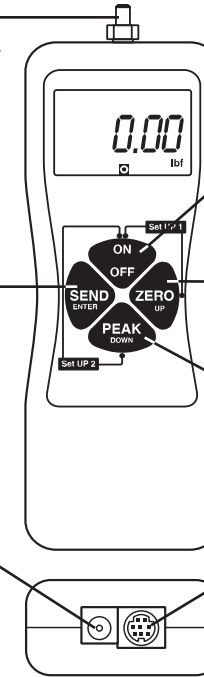

### On/Off

Power ON, capacity is displayed. After 10 minutes, unit powers down if no key is pressed.

### Zero

Tares weight of attachment and resets peak value

### Peak

Press to activate Peak mode

### RS-232 Port

See page 8 for pin assignments

## LCD DISPLAY



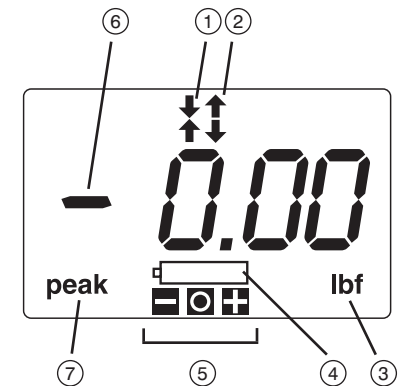

- ① **Compression icon**  
Indicates compression measurement
- ② **Tension icon**  
Indicates tension measurement
- ③ **Units indicator**  
Displays selected measuring unit. (ozf, lbf, kgf or N).
- ④ **Battery icon**  
Flashes when gauge needs to be recharged
- ⑤ **GO/NG Indicator**  
  - under low setpoint
  - between low and high setpoints
  - ⊕ over high setpoint
- ⑥ **Negative sign**  
Displayed when measuring tension
- ⑦ **Peak icon**  
Displays continuously when peak mode is active



## GENERAL OPERATION





### Selecting Units

Press  to turn on the gauge. The display briefly shows the gauge capacity, then zero with a measuring unit. To change to other units:

1. Turn off the gauge.
2. Hold  and press  once. Press  to cycle units (ozf or lbf, gf or kgf, and N), then press  to select. The LCD display briefly shows the gauge capacity, then zero with the newly selected measuring unit, which is retained as a default.

### Reversing the Display

Press  and the LCD display briefly shows the gauge capacity and then zero. To reverse the display:

1. Turn off the gauge.
2. Hold  and press  once. Press  to cycle between standard and reverse display, then press  to select. The LCD display briefly shows gauge capacity and then zero with the newly selected display, which is retained as a default.

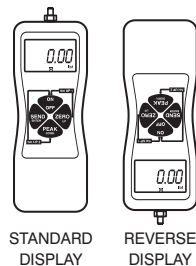

## 2. Mitutoyo Digimatic

Connect the CB-301 cable to the communications port and the device receiving the data. Set up parameters as instructed from the Mitutoyo processor manual.

## 3. ±1 VDC Analog Signal

Connect the CB-101 analog cable to the communications port and the device receiving the data.

### DS2 Ranges (Resolution) Accuracy: ±0.2% F.S. ±1 LSD

Model	Capacity (Resolution)		
	Ounces (ozf)/ Pounds (lbf)	Grams (gf)/ Kilograms (kgf)	Newtons
DS2-0.4	7.00 (0.01 ozf)	200.0 (0.1 gf)	2.000 (0.001 N)
DS2-1	18.00 (0.01 ozf)	500.0 (0.1 gf)	5.000 (0.001 N)
DS2-4	4.400 (0.001 lbf)	2.000 (0.001 kgf)	20.00 (0.01 N)
DS2-11	11.00 (0.01 lbf)	5.000 (0.001 kgf)	50.00 (0.01 N)
DS2-44	44.00 (0.01 lbf)	20.00 (0.01 kgf)	200.0 (0.1 N)
DS2-110	110.0 (0.1 lbf)	50.00 (0.01 kgf)	500.0 (0.1 N)
DS2-220	220.0 (0.1 lbf)	100.0 (0.1 kgf)	1000 (1 N)

### DS2 Specifications

Accuracy	± 0.2% F.S., ± 1 LSD
Selectable Units	lbf(ozf), kgf(gf) or Newtons
Overload Capacity	200% of F.S. (Overload indicator flashes beyond 110% of F.S.)
Data processing speed	1,000 data/second (30 data/second rate selectable)
Display Update	10 times/second
Power	Rechargeable NI-MH battery pack or AC adapter
Battery Indicator	Display flashes battery icon when battery is low
CPU	8-bit CMOS
Setpoints	Programmable high/low setpoints with LCD indicators
Outputs	RS-232C, Digimatic and ±1 VDC analog output
Operating Temp.	32° to 100°F (0° to 40°C)
Accessories included	AC adapter/charger, hook, flat tip, conical tip, chisel tip, notched tip, extension shaft

# COMMUNICATIONS PORT

## Port Pin Assignments

Pin#	Definition
1	RS-232C and Digimatic Ground
2	RS-232C Transmit Data
3	Analog Output $\pm 1VDC$
4	Digimatic Data Request
5	RS-232C Receive Data
6	Analog Ground
7	Digimatic Clock
8	Digimatic Transmit Data

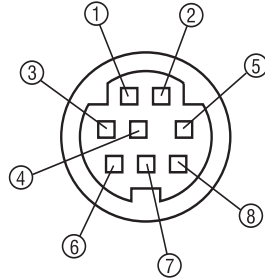

### 1. RS-232C Bi-directional Interface Functions

Connect the gauge and device receiving data with a CB-203 cable. All gauge functions can be duplicated from a remote location by using the RS-232C interface. All commands must be sent in upper-case ASCII character format followed by a carriage return (CR). Signal level: RS-232C, 8 data bits, 1 stop bit, no parity bit  
Baud rate: 19200 bps

### RS-232C Interface Functions (Upper case ASCII format)

Command	Function	Response*
K[CR]	Select "kgf/gf" units	R[CR] executed E[CR] error*
N[CR]	Select "N" units	
O[CR]	Select "lbf/ozf" units	
P[CR]	Select peak mode	
T[CR]	Select real time mode	
Z[CR]	Tare Display	
Q[CR]	Turn off power	
EHHHLLLL[CR]**	Set high/low setpoints(4 digit) HHHH=High, LLLL=Low	
E[CR]**	Read high/low setpoints	EHHHLLLL[CR]** setpoint values (4 digit) HHHH=High, LLLL=Low
D[CR]	Transmit display data	[value][units][mode][CR]

\*E[CR] response if the command is not accepted.

\*\*Ignore decimal point for high low setpoints

## Hand Tighten Attachments

Do not use tools to tighten attachments to the measuring shaft.

## Selecting Peak or Real Time Measuring Mode

Press **ON OFF** to turn on the gauge and enter real time mode. For peak measurement press **PEAK DOWN**. 'Peak' appears on the display. Peak readings will not change until a higher value is measured. Press **PEAK DOWN** again to return to real time mode.

## Tare

If necessary, press **ZERO UP** to tare the weight of the attachment and shaft. Pressing **ZERO UP** also clears the peak reading.

## Apply Force and Measure

Make sure to apply force in line with the gauge measuring shaft.

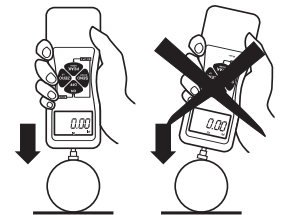

## Collecting Data









Connect the gauge and PC with a CB203 cable. Measure and press **SEND ENTER** to transmit data to the PC. Use optional SW-1 (see page 10) or other software to collect and display data.



## OPTIONAL SETTINGS

The following steps are not necessary for most test applications and may be skipped entirely.

### Selecting High and Low Setpoints





Program High and Low setpoints to enable GO/NG testing.

1. Turn off the gauge.
2. Hold  and press  once. The LCD display will briefly show HI, then the High setpoint value with flashing HI. Press  to increase and  to decrease the High value, then press  to select. The LCD display briefly shows Lo and then Low setpoint value with flashing L. Press  to increase and  to decrease the Low value, then press  to select.

*For example, 5 lbf is set as Low setpoint and 10 lbf as the High setpoint, the GO/NG indicator on the LCD display shows  for measurements less than 5 lbf (Low setpoint).  for measurements between 5-10 lbf and  for over 10 lbf (High setpoint).*

### Selecting Test Type (continued from step 2)

Select rapid data processing for Destructive Testing.

3. After  is pressed in step 2, the display briefly shows **F-AdC** and then **FA** with flashing **F**.
4. Press  or  to cycle between **FA** (for Destructive Testing) or **SL** (for Non-destructive Testing: Factory default), then press  to select. The LCD display briefly shows the gauge capacity and then zero.

**SL:** Non-destructive Testing

(for most testing, 30 data/second)

**FA:** Destructive Testing

(for very rapid force changes, 1,000 data/second)