

**11.0 WARRANTY**

ELECTROMATIC Equipment Co., Inc. (ELECTROMATIC) warrants to the original purchaser that this product is of merchantable quality and confirms in kind and quality with the descriptions and specifications thereof. Product failure or malfunction arising out of any defect in workmanship or material in the product existing at the time of delivery thereof which manifests itself within one year from the sale of such product, shall be remedied by repair or replacement of such product, at ELECTROMATIC's option, except where unauthorized repair, disassembly, tampering, abuse or misapplication has taken place, as determined by ELECTROMATIC. All returns for warranty or non-warranty repairs and/or replacement must be authorized by ELECTROMATIC, in advance, with all repacking and shipping expenses to the address below to be borne by the purchaser.

**THE FOREGOING WARRANTY IS IN LIEU OF ALL OTHER WARRANTIES, EXPRESSED OR IMPLIED, INCLUDING BUT NOT LIMITED TO, THE WARRANTY OF MERCHANTABILITY AND FITNESS FOR ANY PARTICULAR PURPOSE OR APPLICATION. ELECTROMATIC SHALL NOT BE RESPONSIBLE NOR LIABLE FOR ANY CONSEQUENTIAL DAMAGE, OF ANY KIND OR NATURE, RESULTING FROM THE USE OF SUPPLIED EQUIPMENT, WHETHER SUCH DAMAGE OCCURS OR IS DISCOVERED BEFORE, UPON OR AFTER REPLACEMENT OR REPAIR, AND WHETHER OR NOT SUCH DAMAGE IS CAUSED BY MANUFACTURER'S OR SUPPLIER'S NEGLIGENCE WITHIN ONE YEAR FROM INVOICE DATE.**

Some State jurisdictions or States do not allow the exclusion or limitation of incidental or consequential damages, so the above limitation may not apply to you. The duration of any implied warranty, including, without limitation, fitness for any particular purpose and merchantability with respect to this product, is limited to the duration of the foregoing warranty. Some states do not allow limitations on how long an implied warranty lasts but, notwithstanding, this warranty, in the absence of such limitations, shall extend for one year from the date of invoice.

ELECTROMATIC Equipment Co., Inc.  
600 Oakland Ave. Cedarhurst, NY 11516—USA  
Tel: 1-800-645-4330/ Tel: 516-295-4300/ Fax: 516-295-4399

Every precaution has been taken in the preparation of this manual. Electromatic Equipment Co., Inc., assumes no responsibility for errors or omissions. Neither is any liability assumed for damages resulting from the use of information contained herein. Any brand or product names mentioned herein are used for identification purposes only, and are trademarks or registered trademarks of their respective holders.

**TABLE OF CONTENTS**

1.0	Introduction	2
2.0	Overview	3
3.0	Contents of Complete Kit	4
4.0	Installing/Replacing Batteries	5
5.0	Measuring RPM – Non-Contact Mode	6
6.0	Measuring RPM – Contact Mode	7
7.0	Measuring Surface Speed & Length	8
8.0	Built-in Memory System	9
9.0	Range & Accuracy	10
10.0	Specifications	11
11.0	Warranty	12

## 1.0 INTRODUCTION

The DT-205L and DT-207L Hand-Held Digital Tachometers are combination models designed for Contact as well as Non-Contact operation. They employ a precise Optical Laser System that permits measurement of RPM from up to 14 feet away when operating in the Non-Contact mode and is supplied with a Screw-In Contact Adapter for measuring RPM, Surface Speed & Length in the Contact operating mode. Rotational speed is displayed in RPM units (revolutions per minute) while the surface speed and length can be displayed in a variety of user-selected engineering units.

When operating in the Non-Contact mode a small piece of reflective tape must be affixed to the rotating shaft or other rotating element. Refer to Operating Procedure

Non-Contact RPM

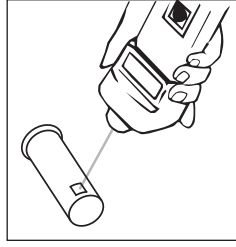

Contact RPM

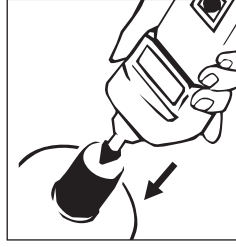

Surface Speed & Length

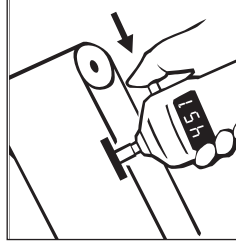

## 10.0 SPECIFICATIONS

<b>Models</b>	DT-205L (LCD version) DT-207L (LED version)
<b>Measuring Range</b>	Non-Contact: 6 to 99,999 rpm Contact : 0.8 to 25,000 rpm
<b>Accuracy</b>	6 to 8,299 rpm: $\pm 1$ rpm 8,300 to 24,999 rpm: $\pm 2$ rpm 25,000 to 99,999 rpm: $\pm 0.006\%$ rpm
<b>Display</b>	DT-205L (LCD MODEL) 5 digit 0.47" (12mm) high LCD DT-207L (LED MODEL) 5 digit 0.4" (10mm) high LED
<b>Measuring Units</b> <i>per Minute</i> <i>Total Length</i>	Revolutions, Meters, Yards, Feet, Inches Meters, Yards, Feet, Inches
<b>Measuring Distance</b>	14 feet (5.2 m) maximum
<b>Detection</b>	Laser Diode, Class II
<b>Memory</b>	13 readings are stored in memory and retained for 5 minutes (last, max., min., and 10 measurements)
<b>Over-Range Indicator</b>	Flashing numerals
<b>Update Time</b>	1 second (typical)
<b>Batteries</b>	2 (1.5 V AA)
<b>Battery Life</b>	DT-205L: Approx 40 hrs DT-207L: Approx 25 hrs
<b>Operating Temp</b>	32° to 113° F (0 to 45° C)
<b>Construction</b>	Die-cast aluminum housing
<b>Weight</b>	0.8 pounds (365 grams)
<b>Dimensions</b>	6.6" L x 2.4" W x 1.8" H (167mm x 61mm x 45.7mm)
<b>Warranty</b>	1 year

**Do not point the laser beam into eyes as permanent damage could result.**

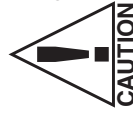

## 9.0 RANGE AND ACCURACY

Model		DT-207L	
<b>R: Revolutions</b>	<b>Single Range</b>	<b>Accuracy</b>	<b>Resolution</b>
Non-Contact RPM (rev./min.)	6 – 8,300 8,300 – 25,000 25,000 – 99,999	±1 ±2 ±0.006% of reading ±1 digit (or ±6 RPM max.)	1
Contact RMP (rev./min.)	0.8 – 9,999.9 10,000 – 25,000	±0.6% ±0.006% of reading ±1 digit (or ±2 RPM max.)	0.1 1
<b>F: Feet</b>	<b>Single Range</b>	<b>Accuracy</b>	<b>Resolution</b>
F/M (feet/min.)	0.4 – 9,999.9 10,000 – 12,500	±0.6% ±1	0.1 1
FT (feet)	0.10 – 999.99 1,000 – 9,999.9 10,000 – 99,999		0.01 0.1 1
<b>Y: Yards</b>	<b>Single Range</b>	<b>Accuracy</b>	<b>Resolution</b>
Y/M (yards/min)	0.13 – 999.99 1,000.0 – 4,167.0	±0.06 ±0.3	0.01 0.1
Y/Rd (length)	0.02 – 999.99 1,000.0 – 9,999.9 10,000 – 99,999		0.01 0.1 1
<b>I: Inches</b>	<b>Single Range</b>	<b>Accuracy</b>	<b>Resolution</b>
I/M (inches/min.)	5 – 99,999	±0.006% of reading ±1 digit (or ±6 RPM max.)	1
IN (length)	1.0 – 9,999.9 10,000 – 99,999		0.1 1
<b>m: Meters</b>	<b>Single Range</b>	<b>Accuracy</b>	<b>Resolution</b>
m/M (meters/min.)	0.11 – 999.99 1,000.0 – 3,810.0	±0.06 ±3	0.01 0.1
m (length)	0.02 – 999.99 1,000.0 – 9,999.9 10,000 – 99,999		0.01 0.1 1

**Note:** When using the 6" master wheel, accuracy can be affected as much as 0.3% of reading

Although the tachometer alone is able to achieve the above ranges, the master wheel has a maximum speed limitation of 5,000 FPM (for safety reasons)



## 2.0 OVERVIEW



LCD Display on DT-205L



LED Display on DT-207L



### 3.0 CONTENTS OF COMPLETE KIT

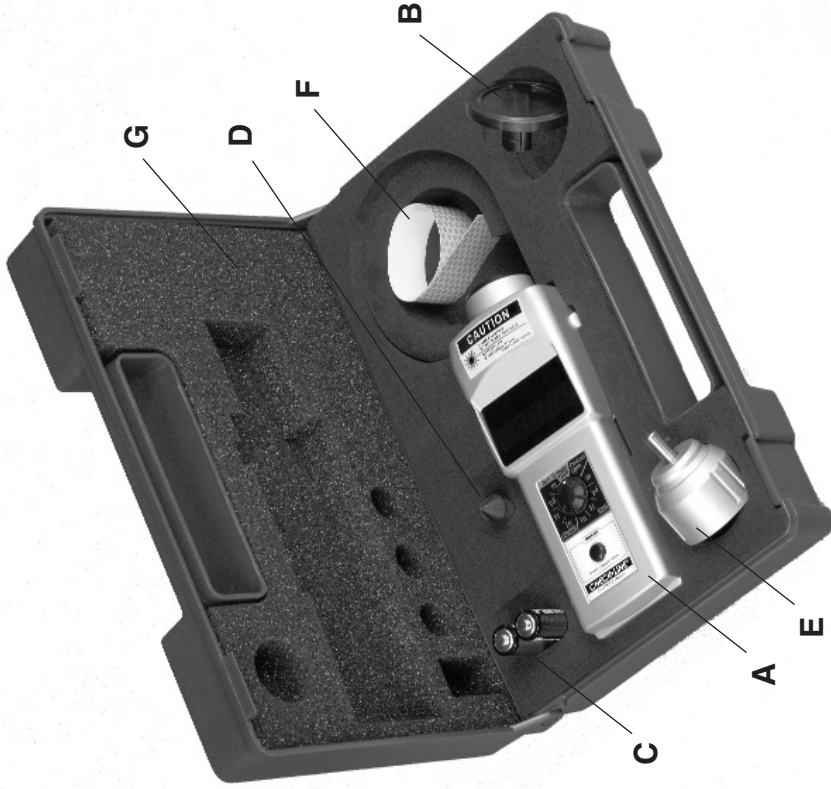

- A. Tachometer
  - B. Surface Speed Wheel
  - C. Batteries (2 pcs. x AA)
  - D. Cone Tip Adapter
  - E. Screw-In Contact Adaptor
  - F. Reflective Tape
  - G. Carrying Case
- Not shown — Instruction manual stored behind foam

### 8.0 BUILT-IN MEMORY SYSTEM

The DT-205L and DT-207L include an automatic built-in memory system capable of storing the Last, Maximum and Minimum readings for recall to the display. These values are stored automatically and there is no need to press any buttons to store data.

**Note:**

- When utilizing the Length Measurement functions, only the Last reading is retained in the display.
- The stored data will be deleted when the Tachometer automatically powers off.

#### **Recall Stored Readings**

To recall stored readings to the display, press the Memory Switch. A stored value will alternately flash on the display along with the memory location number (1, 2 ...10).

#### **Clearing Stored Readings**

To erase all stored readings, press and hold the Memory Switch for five (5) or more seconds until the display shows “CCCCC.” This indicates that the memory was successfully erased.

## 7.0 MEASURING SURFACE SPEED & LENGTH

1. Select the Surface Speed Wheel and carefully place it on the shaft of the Screw-in Contact Adapter making sure to align the pin on the shaft with the slot on the wheel.

**Warnings:** The *Shaft Extension Accessory* should not be used with the *Surface Speed Wheel*.

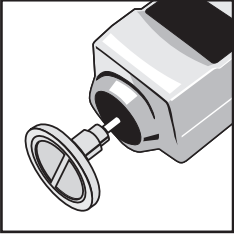

2. Rotate the *Operating Mode Selector Switch* to the desired unit of measure for surface speed or length.

*Select Desired Unit Of Measure  
For Surface Speed or Length*

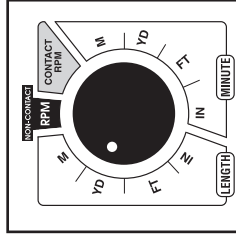

3. Position the wheel carefully on the moving surface. Apply enough pressure to eliminate any slip.

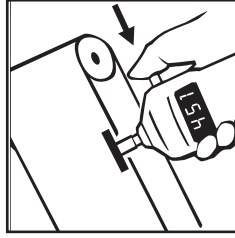

4. Press and hold the *white Measure Button* located on the right side of the Tachometer.
5. The display will update approximately 1 time per second and show the measured surface speed or length in the units selected in the *Operating Mode Selector Switch*.
6. Release the *Measure Button* prior to removing the Tachometer from the rotating shaft. The last reading will be retained on the display.

Readings will be retained in memory for 5 minutes. This time can be extended indefinitely by re-pressing the *Memory Switch* within each five minute period.

## 4.0 INSTALLING/REPLACING BATTERIES

1. Loosen the two black screws at the bottom edge of the tachometer using a slotted screwdriver or coin.

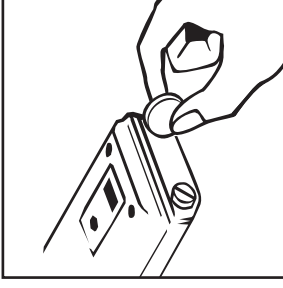

2. Remove the battery compartment cover plate exposing the battery sleeve.

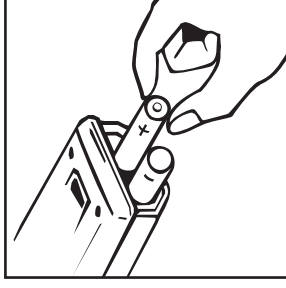

3. Insert the AA batteries observing the proper battery polarity indicated on a label inside the battery compartment

**Note:** The DT-205L and DT-207L are designed to automatically power off after five (5) minutes of "non-use" to conserve battery power.

## 5.0 MEASURING RPM - Non-Contact Mode

1. Place a small piece of Reflective Tape (included) on the shaft or rotating element (disc, pulley, etc.).

### Notes On Measurements:

- If the rotating element is highly reflective, it may be necessary to paint it a darker color in order to ensure reliable results.
  - If the sensing distance to the object is less than 5 inches (127 mm), Reflective Tabs (optionally available) should be used instead of the Reflective Tape included with the instrument.
2. Aim the Tachometer at the target (Reflective Tape) keeping the Tachometer at least 5" (127 mm) but no more than 14 Feet (4.3 meters) away from the reflective target.

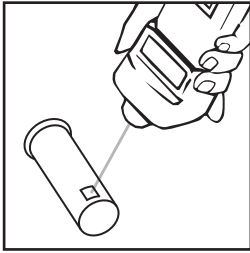

3. Press and hold the Measure Button for several seconds to observe the display as it changes in accordance with the speed of the shaft or rotating element. As soon as the laser beam hits the target, the Tachometer will begin displaying speed measurements.

If the laser beam is properly aligned with the target, an "on target" indicator will be shown on the display.

DF-205L: "RPM" Indicator flashes on and off

DF-207L: "Red Dot" flashes on and off

If the above indicators are not flashing, then the beam is not correctly aligned with the reflective tape.

4. Release the Measure Button prior to removing the Tachometer from the rotating shaft. The last reading will be retained on the display.

Readings will be retained in memory for 5 minutes. This time can be extended indefinitely by re-pressing the Memory Switch within each five minute period.

## 6.0 MEASURING RPM— Contact Mode

1. Screw in the Contact Adapter on to the front of the unit.

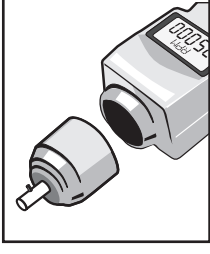

2. Select either the Cone Tip Adapter or the Funnel Tip Adapter and carefully place it on the shaft of the Screw-in Contact Adapter making sure to align the pin on the shaft with the slot on the adapter.

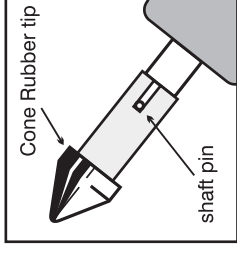

**Note:** The shaft extension accessory can be used to help reach the end of the shaft, however, under no circumstances should this extension be used with the Surface Speed Wheel.

3. Rotate the Operating Mode Selector Switch to Contact RPM.

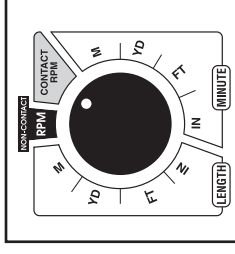

4. Position the tip carefully on the end rotating shaft insuring that it is positioned in the center of the shaft. Apply enough pressure to eliminate slip.

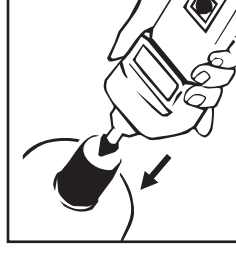

5. Press and hold the white Measure Button located on the right side of the Tachometer.
6. The display will update approximately 1 time per second and show the measured rotational speed in RPM.
7. Release the Measure Button prior to removing the Tachometer from the rotating shaft. The last reading will be retained on the display.

Readings will be retained in memory for 5 minutes. This time can be extended indefinitely by re-pressing the Memory Switch within each five minute period.

**CHECKLINE®**  
BY ELECTROMATIC

Hand Held

# DIGITAL TACHOMETER

Model DT-205L and DT-207L



**ELECTROMATIC**  
E Q U I P M E N T C O . I N C .

600 Oakland Ave., Cedarhurst, NY 11516-U.S.A.  
TEL: 516-295-4300 • FAX: 516-295-4399

**CHECKLINE®**  
INSTRUMENTS

O P E R A T I N G M A N U A L